



Connero 1

Product number: 3011105

Configuration: black matt, H 720 mm

Configuration options

3011105 | black matt, H 720 mm

3011106 | black matt, H 870 mm

3011107 | black matt, H 1100 mm

✓ Support foot

✓ square

✓ straight

Supporting foot, square, may not be shortened.

— height plus 5 mm height adjustment

— tube 70 x 70 mm

— can be mounted flush to corner/centrally

— load-bearing capacity ca. 120 kg

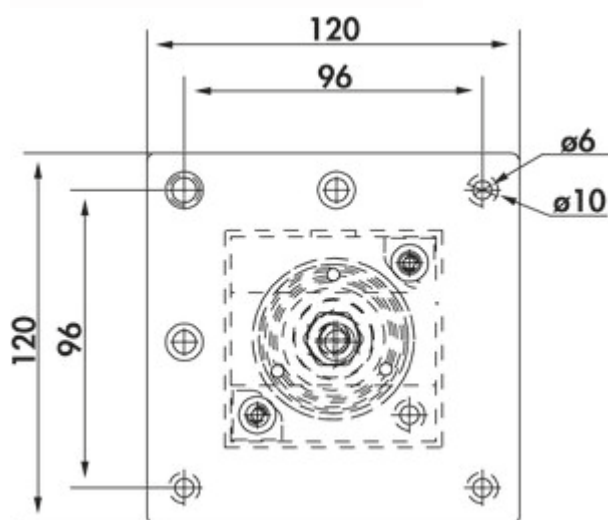

[more infos...](#)

Technical data

Article type	Support foot	Length of the supply line (primary)	1.900 mm
Height	720 mm	With mounting plate	Yes
Width	70 mm	Carrying capacity	120 kg
Properties	cannot be shortened	Tube dimension	70 x 70 mm
Mounting/Fixing	flush with the corner possible in the middle	Height adjustment	5 mm
Surface/coating	matt	Support element version	straight
Shape	square	Mounting height on console	2 mm

Dimensional sketch (PDF)

