



Kreta 1 slanted

Product number: 3023028

Configuration: stainless steel coloured, H 170 mm

Configuration options

3023022 | stainless steel coloured, H 190 mm

3023023 | stainless steel coloured, H 230 mm

3023028 | stainless steel coloured, H 170 mm

3023030 | black matt, H 170 mm

3023031 | black matt, H 190 mm

3023032 | black matt, H 230 mm

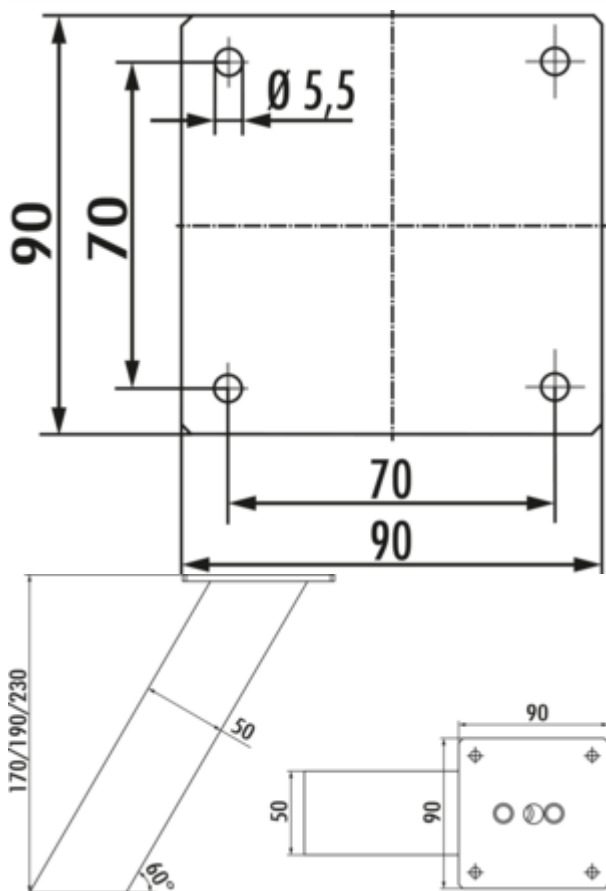

- ✓ Console
- ✓ Material: aluminium
- ✓ angular

Console.

— slanted

— aluminium profile 50 x 50 mm, milled

— slant angle 60°

— max. load per pair approx. 60 kg given even distribution, max. spacing of the consoles of 900 mm and max. projection of the plates of 250 mm

[more infos...](#)

Technical data

Article type	Console	Dimensions profile	50 x 50 mm
Height	170 mm	Carrying capacity	max. load per pair approx. 60 kg given even distribution, max. spacing of the consoles of 900 mm and max. projection of the plates of 250 mm
Width	50 mm	Inclination angle	60°
Material	aluminium	Support element version	slanted
Surface/coating	polished	Dimensions support surface	90 x 90 mm
Shape	angular	Material profile	aluminium

Dimensional sketch (PDF)

