

newcomer 2024



Attractive new products:
VIVACE storage,
ACCOMODA® niche rear wall,
ARMATE® SERVIZIO faucet

ALL
HIGHLIGHTS
IN OUR
ONLINE SHOP!

naber.com

NEWCOMER
DOWNLOAD:



Naber[®]
... inspires!

   
Follow us!

Highlights in autumn

There are surprises in store! The **highlights in autumn** are diverse, feature completely new products, the latest additions to the range – and a **fresh product group!** In detail:

"**Next level lighting control**" is the motto of **LUMICA®**: the **Naber MEC converter system** (suitable for 12 and 24 V) makes control solutions for attractive lighting scenarios extremely simple – and with the current ZigBee 3.0 standard, it provides greater compatibility with living room lights from other manufacturers. **MEC** comes with modules for various sensors, enabling countless options.

ARMATE® has added some important updates to the high-quality **stainless steel faucet series Namor®**: **Namor® 1, 3 and 5** (in stainless steel look or matt black) are now also available as low-pressure single-lever mixers and as window faucets. **Namor® 3 and 4** are also available in the current **trend colour Gunmetal**. The low-pressure faucet **Namor® 7** (stainless steel or matt black) with its self-confident L-shape is entirely new.

The extensive **TABLON® interior range** is further rounded off by a variety of new chairs and stools. Clear Scandinavian design meets trendy colours and water-proof, extremely durable fabrics.

VIVACE is the name of our fresh product group with the categories **waste collectors, outdoor** and **storage**. All multi-containers work perfectly and are imaginative, colourful and extremely robust. **Invented by WESCO, systematically continued by Naber!**



LUMICA® MEC converter – "next level lighting control" with a clear structure and countless options

Namor faucet series® with new single-lever mixers – including low-pressure and window faucets





TABLON® – new chairs and stools enhance the comprehensive interior range

Contents

- ARMATE®
Faucets
- SELEKATkit®
Waste collectors
- LUMICA®
Lighting technology
- CON-AKTIV®
Sockets
- STOREX®
Cabinet equipment
- ACCOMODA®
Niche equipment
- VIVACE
Multi containers
- TABLON®
Interiors



Namor®

The high-quality stainless steel Namor® series of faucets stands for three contemporary design concepts and guarantees maximum user benefits in all shapes and forms. Whether stylishly linear, self-confidently L-shaped or elegantly C-shaped – Namor® kitchen faucets convince with their aesthetic perfection and technical precision. In every design, the Namor® faucets impress with their slender lever and their stainless steel and matt black colours. Each design includes two versions: the faucet with swivelling outlet and the faucet with swivelling and pull-out hose with shower head.

With a five-year manufacturer's guarantee, we provide comprehensive customer service in Germany and Austria.

Stainless steel

5 years manufacturer's warranty (except on wearing parts)

Factory customer service in Germany, Austria and the Netherlands

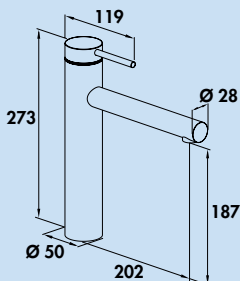

Namor® 1



Single lever faucet. With swivelling outlet, laminar aerator and ceramic cartridge.

– swivel range 120°

– drill Ø 35 mm

5025001 stainless steel, with laminar aerator, high pressure **284.87 €**

5025013 stainless steel, without laminar aerator, low pressure **NEW!** **299.16 €**

5025002 black matt, with laminar aerator, high pressure **327.73 €**

5025014 black matt, without laminar aerator, low pressure **NEW!** **344.54 €**

Expected to be available from February 2025.

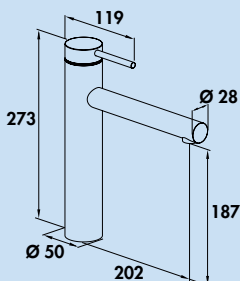

Namor® 1 window fitting

NEW!



Single lever faucet. With swivelling outlet, laminar aerator and ceramic cartridge.

– **height when tilted only 25 mm**

– swivel range 120°

– drill Ø 35 mm

5025031 stainless steel, high pressure **313.45 €**

5025032 black matt, high pressure **361.34 €**

Expected to be available from February 2025.

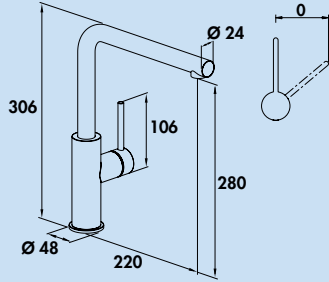

Namor® 3



Single lever faucet. With swivelling outlet, side lever and ceramic cartridge.
 – swivel range 120°
 – drill Ø 35 mm

5025005 stainless steel, with laminar aerator, high pressure 259.66 €

5025015 stainless steel, without laminar aerator, low pressure **NEW!** 298.32 €

5025006 black matt, with laminar aerator, high pressure 298.32 €

5025016 black matt, without laminar aerator, low pressure **NEW!** 343.70 €

5025044 gunmetal, with laminar aerator, high pressure **NEW!** 326.05 €

Expected to be available from February 2025.

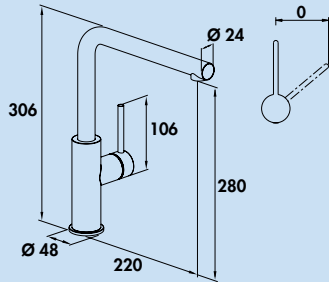

Namor® 3 window fitting

NEW!



Single lever faucet. With swivelling outlet, side lever, laminar aerator and ceramic cartridge.

- height when tilted only 25 mm
- swivel range 120°
- drill Ø 35 mm

5025033 stainless steel, high pressure 311.76 €

5025034 black matt, high pressure 358.82 €

Expected to be available from February 2025.

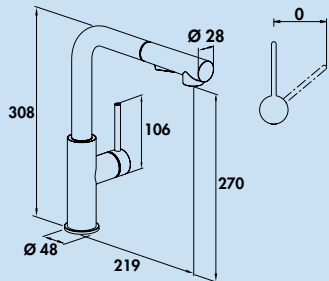

Namor® 4



Single lever mixer. With swivelling/pull-out hose with shower head (can be switched to stream or shower), side lever, laminar aerator and ceramic cartridge.

- swivel range 120°
- drill Ø 35 mm
- shower hose: simple click fastening

Expected to be available from February 2025.

5025007 stainless steel, high pressure 344.54 €

5025008 black matt, high pressure 396.64 €

5025045 gunmetal, high pressure **NEW!** 436.97 €

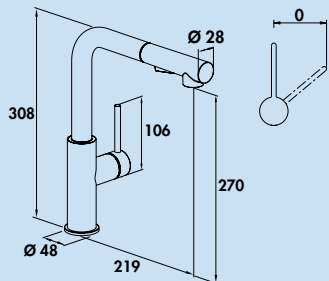

Namor® 4 window fitting

NEW!



Single lever faucet. With swivelling/pull-out hose with shower head (can be switched to stream or shower), side lever, laminar aerator and ceramic cartridge.

- height when tilted only 50 mm
- swivel range 120°
- drill Ø 35 mm

5025035 stainless steel, high pressure 431.09 €

5025036 black matt, high pressure 495.80 €

Expected to be available from February 2025.

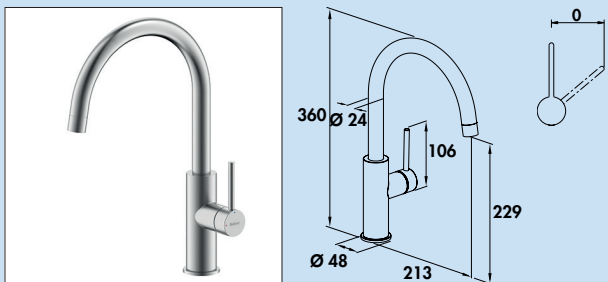

Namor® 5



Single lever mixer. With swivelling outlet, side lever and ceramic cartridge.
 – swivel range 120°
 – drill Ø 35 mm

5025009 stainless steel, with laminar aerator, high pressure 259.66 €

5025038 stainless steel, without laminar aerator, low pressure **NEW!** 298.32 €

5025010 black matt, with laminar aerator, high pressure 298.32 €

5025039 stainless steel, without laminar aerator, low pressure **NEW!** 343.70 €

Expected to be available from February 2025.

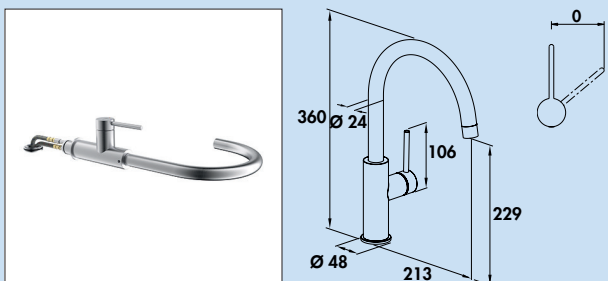

Namor® 5 window fitting

NEW!



Single lever faucet. With swivelling outlet, side lever, laminar aerator and ceramic cartridge.

- height when tilted only 25 mm
- swivel range 120°
- drill Ø 35 mm

5025042 stainless steel, high pressure 311.76 €

5025043 black matt, high pressure 358.82 €

Expected to be available from February 2025.

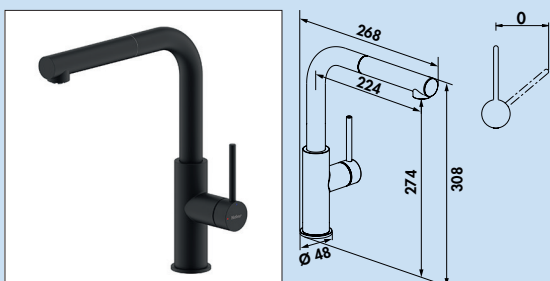

Namor® 7

NEW!



Single lever mixer. With swivelling/pull-out outlet, side lever and ceramic cartridge.

- swivel range 120°
- drill Ø 35 mm

5025017 stainless steel, low pressure **NEW!** 431.09 €

5025019 black matt, low pressure **NEW!** 495.80 €

Expected to be available from February 2025.



Aria

NEW!

Aria combines the best possible ease of use with a strong and glamorous appearance. The flexible hose is elegantly mounted at the front, where it can easily be detached and moved in all directions. The swivelling range of 360 degrees enables further radius of operation. This new form of absolute versatility is matched by the stunning design. Robust and elegant all at once, Aria is a statement of professionalism in the kitchen. It is available as a striking eye-catcher in a single colour and as a glamorous centrepiece for the kitchen in a two-colour version. The energy-saving Cold-Start technology is integrated.

10 years manufacturer's warranty (except on wearing parts)

Factory customer service in Germany and Austria

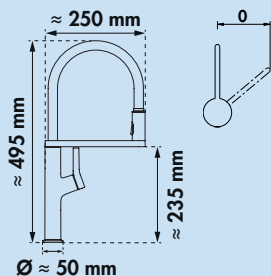

Aria



Single lever faucet. With **swivelling/pull-out** outlet, side lever, ceramic cartridge.
 — energy-saving cold start function
 — swivel range 360°
 — drill Ø 35 mm

5021315	stainless steel coloured, high pressure	492.79 €
5021316	black matt, high pressure	525.30 €
5021317	black-rose-gold, high pressure	548.21 €
5021318	black-brushed-gold, high pressure	548.21 €
5021319	graphite matt, high pressure	637.46 €

Expected to be available from February 2025.



Kristea

NEW!

Kristea impressively demonstrates the great care and attention that has gone into creating a contemporary and yet timeless faucet design. The perfect synopsis of the round and the angular produces a high outlet, which exudes pure aesthetics in three trendy colours. Each colour stands for its own furnishing style: from contemporary with matt black to rustic with matt graphite and art deco with brushed gold. Technically, Kristea impresses with utmost precision and energy-efficient Cold-Start technology. The pull-out outlet and the largest possible swivelling range of 360 degrees provide for particular ease of use.

10 years manufacturer's warranty (except on wearing parts)

Factory customer service in Germany and Austria

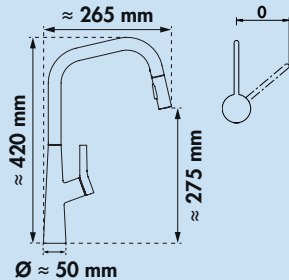

Kristea



Single lever faucet. With **swivelling/pull-out** outlet, side lever, ceramic cartridge.
 — energy-saving cold start function
 — swivel range 360°
 — drill Ø 35 mm

5021320 black matt, high pressure	456.83 €
5021321 brushed-gold, high pressure	548.21 €
5021322 graphite matt, high pressure	571.58 €

Expected to be available from February 2025.



Pullboy Soft Comfort

NEW!

Waste collector as a front pull-out system with soft-closing mechanism and pull-out locking pins. Available with a fixed lid or with a pull-out lid system incl. anti-slip mat.

- full pull-out runners with self-closing mechanism + damper incl. pull-out safety lock, 30 kg load capacity, LGA tested
- due to its low depth of 330 mm, it still leaves enough space in the sink base unit for a siphon and other under-sink appliances
- the installation is very simple using the **Comfort Plus metal installation template**
- 3D positioning makes subsequent adjustment quick and easy

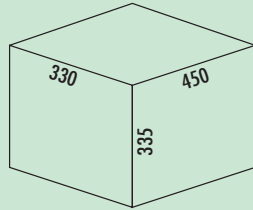
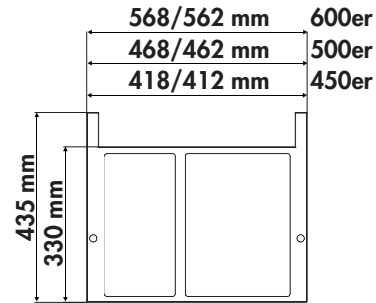

Pullboy Soft Comfort 335 K/450-2

With a fixed lid. Incl. pull-out locking pins.

- waste volume 22 (2 x 11) litres
- dimensions: 412 x 335 x 330 mm (W x H x D)
- installation: side wall mounting with front panel
- waste system with soft retraction and damping
- for 16/19 mm side walls

8011122 anthracite

260.50 €

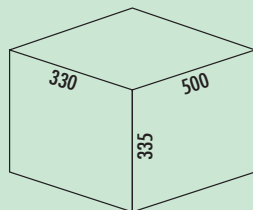

Pullboy Soft Comfort 335 K/500-2

With a fixed lid. Incl. pull-out locking pins.

- waste system with soft retraction and damping
- waste volume 28 (17 + 11) litres
- dimensions: 462 x 335 x 330 mm (W x H x D)
- installation: side wall mounting with front panel
- for 16/19 mm side walls

8011123 anthracite

265.55 €



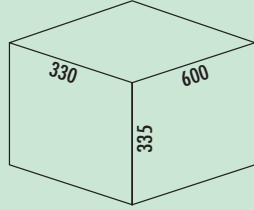

Pullboy Soft Comfort 335 K/600-3

With a fixed lid. **Incl. pull-out locking pins.**

- waste system with soft retraction and damping
- waste volume 33 (2 x 8/1 x 17) litres
- dimensions: 562 x 335 x 330 mm (W x H x D)
- installation: side wall mounting with front panel
- for 16/19 mm side walls

8011124 anthracite

253.78 €

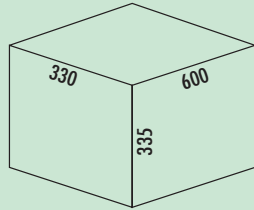

Pullboy Soft Comfort 335 K/600-2

With a fixed lid. **Incl. pull-out locking pins.**

- waste system with soft retraction and damping
- waste volume 34 (2 x 17) litres
- dimensions: 562 x 335 x 330 mm (W x H x D)
- installation: side wall mounting with front panel
- for 16/19 mm side walls

8011125 anthracite

249.58 €

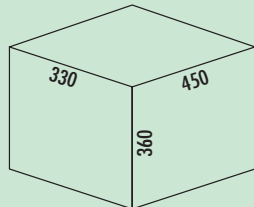

Pullboy Soft Comfort 360 K/450-2

With lid pull-out system and pull-out locking pins. Incl. anti-slip mat.

- waste system with soft retraction and damping
- waste volume 22 (2 x 11) litres
- dimensions: 412 x 360 x 330 mm (W x H x D)
- installation: side wall mounting with front panel
- for 16/19 mm side wall

8011126 anthracite

278.99 €

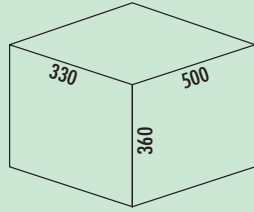

Pullboy Soft Comfort 360 K/500-2

With lid pull-out system and pull-out locking pins. Incl. anti-slip mat.

- waste system with soft retraction and damping
- waste volume 28 (17 + 11) litres
- dimensions: 462 x 360 x 330 mm (W x H x D)
- installation: side wall mounting with front panel
- for 16/19 mm side walls

8011127 anthracite

282.35 €

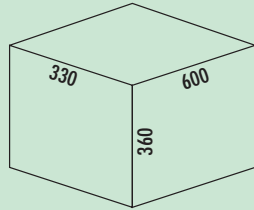

Pullboy Soft Comfort 360 K/600-3

With lid pull-out system and pull-out locking pins. Incl. anti-slip mat.

- waste system with soft retraction and damping
- waste volume 33 (2 x 8/1 x 17) litres
- dimensions: 562 x 360 x 330 mm (W x H x D)
- installation: side wall mounting with front panel
- for 16/19 mm side walls

8011128 anthracite

298.32 €

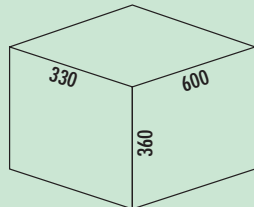

Pullboy Soft Comfort 360 K/600-2

With lid pull-out system and pull-out locking pins. Incl. anti-slip mat.

- waste system with soft retraction and damping
- waste volume 34 (2 x 17) litres
- dimensions: 562 x 360 x 330 mm (W x H x D)
- installation: side wall mounting with front panel
- for 16/19 mm side walls

8011129 anthracite

292.44 €

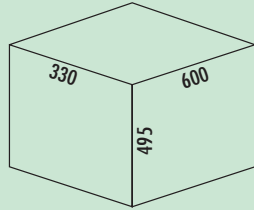

Pullboy Soft Comfort 495 K/600-2

With a fixed lid. Incl. pull-out locking pins.

- waste system with soft retraction and damping
- waste volume 58 (2 x 29) litres
- dimensions: 562 x 495 x 330 mm (W x H x D)
- installation: side wall mounting with front panel
- for 16/19 mm side walls

8011488 anthracite

299.16 €

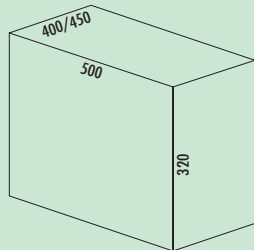

Pullboy Vario 320 S/400-2

NEW!

With non-slip inlay mat and complete lid.

Can be cut to fit all standard drawers.

Cutting dimensions of the mat:

max. 368 x 565 mm (W x D)

min. 230 x 456 (W x D)

- waste capacity 25 (1 x 17/1 x 8) liters
- the ideal space saver with an installation height of only 320 mm

8011605 aluminium grey

99.16 €

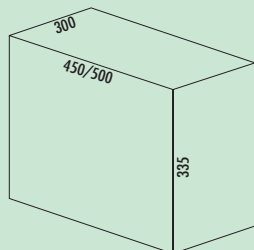

Pullboy Vario 335 S/300-2

NEW!

With non-slip inlay mat and complete lid.

Can be cut to fit all standard drawers.

Cutting dimensions of the mat:

max. 220 x 556 mm (W x D)

min. 140 x 400 mm (W x D)

- waste capacity 25 (1 x 17/1 x 8) liters
- the ideal space saver with an installation height of only 335 mm

8011623 aluminium grey

116.81 €

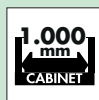
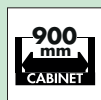
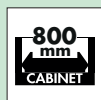
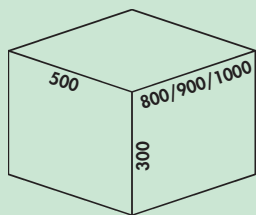

Pullboy Vario 300 S/800-4

NEW!

With non-slip inlay mat and single lid.
Can be cut to fit all standard drawers.

Cutting dimensions of the mat:

max. 1125 x 565 mm (W x T)

min. 468 x 456 mm (W x T)

— waste capacity 50 (2 x 8/2 x 17) liters

— **the ideal space saver with an installation height of only 300 mm**

8011640 aluminium grey

110.08 €

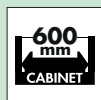
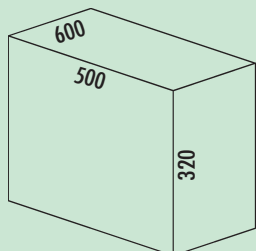

Pullboy Vario 320 S/600-4

NEW!

With non-slip inlay mat and complete lid.

Can be cut to fit all standard drawers.

Cutting dimensions of the mat in mm:

max. 565 x 565 (W x D)

min. 468 x 456 (W x D)

— waste capacity 50 (2 x 8/2 x 17) liters

— **the ideal space saver with an installation height of only 320 mm**

8012006 aluminium grey

173.11 €

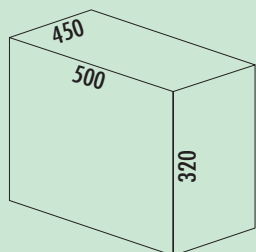

Pullboy Vario 320 S/450-2

NEW!

With non-slip inlay mat and complete lid.

Can be cut to fit all standard drawers.

Cutting dimensions of the mat:

max. 462 x 565 mm (W x T)

min. 311 x 456 (W x T)

— waste capacity 34 (2 x 17) liters

— **the ideal space saver with an installation height of only 320 mm**

8012007 aluminium grey

131.09 €

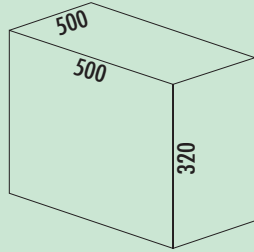

Pullboy Vario 320 S/500-3

NEW!

- With non-slip inlay mat and complete lid.
- Can be cut to fit all standard drawers.
- Cutting dimensions of the mat:
 - max. 462 x 565 mm (W x D)
 - min. 311 x 456 mm (W x D)
- waste capacity 33 (2 x 8/1 x 17) liters
- the ideal space saver with an installation height of only 320 mm

8012010 aluminium grey

138.40 €



Pullboy Versa 265 K

NEW!

- The Pullboy Versa waste system is ideally suited for a front design consisting of several parts and can be cut to size for all pull-outs with a nominal depth of 400 mm.
- with individual lids and the optional fixed complete lid
- with insert tray for secure positioning
- for mounting on existing pull-outs
- the height of the entire system is only 265 mm
- the total lid can be mounted behind the top front to save space

Expected to be available from November 2024.

Container fitting systems/litres					
Cabinet body	500	500	600	600	600
	7	7	15	15	7
	15	7	7	7	7

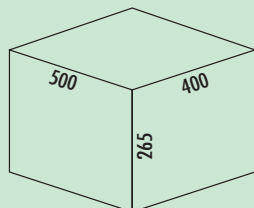
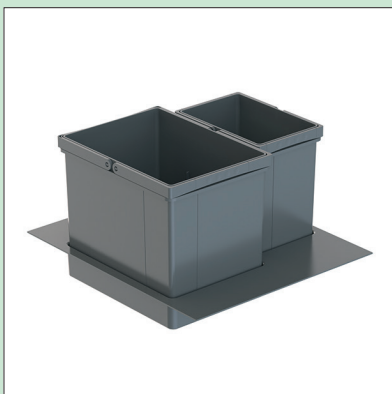

Pullboy Versa 265 K/500-2

- For mounting on existing pull-outs with a nominal depth of 400 mm.
- minimum installation depth (internal dimension of the drawer) 400 mm
- waste volume 22 (1 x 7/1 x 15) litres
- incl. individual lid
- total height 265 mm
- optional complete lid can be mounted behind the upper front to save space
- base tray 462 x 400 mm (W x D), can be cut to size

8011711 orion grey, H 265 mm

79.83 €

Optional accessories

8011718 Pullboy Versa complete lid, 500 mm, orion grey, powder-coated

56.30 €

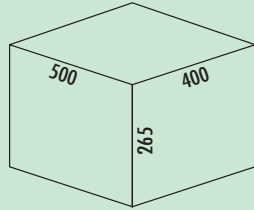

Pullboy Versa 265 K/500-3

- For mounting on existing pull-outs with a nominal depth of 400 mm.
- minimum installation depth (internal dimension of the drawer) 400 mm
 - waste volume 21 (3 x 7) litres
 - incl. individual lid
 - total height 265 mm
 - optional complete lid can be mounted behind the upper front to save space
 - base tray 462 x 400 mm (W x D), can be cut to size

8011710 orion grey, H 265 mm **89.08 €**

Optional accessories

8011718 Pullboy Versa complete lid, 500 mm, orion grey, powder-coated **56.30 €**

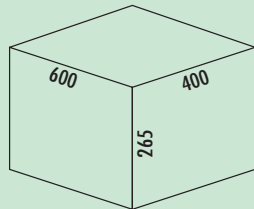
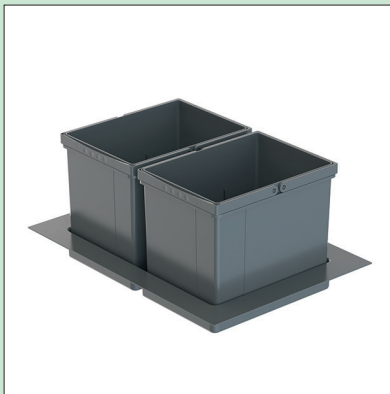

Pullboy Versa 265 K/600-2

- For mounting on existing pull-outs with a nominal depth of 400 mm.
- minimum installation depth (internal dimension of the drawer) 400 mm
 - waste volume 30 (2 x 15) litres
 - incl. individual lid
 - total height 265 mm
 - optional complete lid can be mounted behind the upper front to save space
 - base tray 562 x 400 mm (W x D), can be cut to size

8011715 orion grey, H 265 mm **84.03 €**

Optional accessories

8011719 Pullboy Versa complete lid, 600 mm, orion grey, powder-coated **59.66 €**

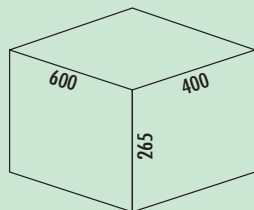
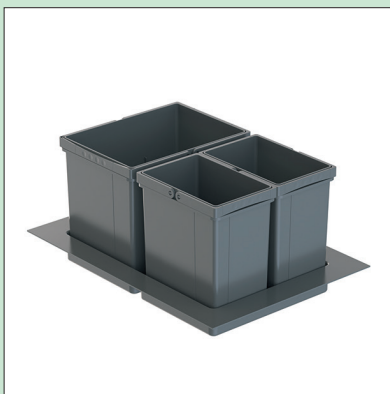

Pullboy Versa 265 K/600-3

- For mounting on existing pull-outs with a nominal depth of 400 mm.
- minimum installation depth (internal dimension of the drawer) 400 mm
 - waste volume 29 (2 x 7/1 x 15) litres
 - incl. individual lid
 - total height 265 mm
 - optional complete lid can be mounted behind the upper front to save space
 - base tray 562 x 400 mm (W x D), can be cut to size

8011716 orion grey, H 265 mm **94.12 €**

Optional accessories

8011719 Pullboy Versa complete lid, 600 mm, orion grey, powder-coated **59.66 €**

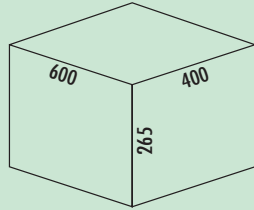
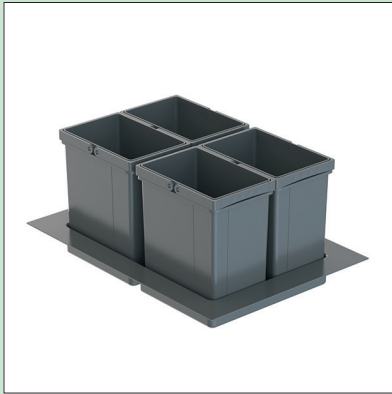

Pullboy Versa 265 K/600-4

- For mounting on existing pull-outs with a nominal depth of 400 mm.
- minimum installation depth (internal dimension of the drawer) 400 mm
 - waste volume 28 (4 x 7) litres
 - incl. individual lid
 - total height 265 mm
 - optional complete lid can be mounted behind the upper front to save space
 - base tray 562 x 400 mm (W x D), can be cut to size

8011714 orion grey, H 265 mm **103.36 €**

Optional accessories

8011719 Pullboy Versa complete lid, 600 mm, orion grey, powder-coated **59.66 €**



Pullboy Versa 265 S NEW!

The Pullboy Versa waste system is ideally suited for a front design consisting of several parts and can be cut to size for all pull-outs with a nominal depth of 500 mm.

- with individual lids and the optional fixed complete lid
- with insert tray for secure positioning
- for mounting on existing pull-outs
- the height of the entire system is only 265 mm
- the complete lid can be mounted behind the top front to save space

Expected to be available from November 2024.

Container fitting systems/litres															
Cabinet body	500	500	600												
	<table border="1"> <tr><td>15</td><td>7</td></tr> <tr><td></td><td>7</td></tr> </table>	15	7		7	<table border="1"> <tr><td>7</td><td>7</td></tr> <tr><td>7</td><td>7</td></tr> </table>	7	7	7	7	<table border="1"> <tr><td>15</td><td>7</td></tr> <tr><td>15</td><td>7</td></tr> </table>	15	7	15	7
15	7														
	7														
7	7														
7	7														
15	7														
15	7														

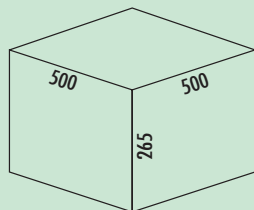
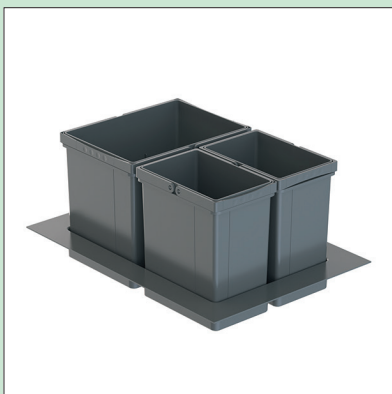

Pullboy Versa 265 S/500-3

- For mounting on existing pull-outs with a nominal depth of 500 mm.
- minimum installation depth (internal dimension of the drawer) 500 mm
 - waste volume 29 (2 x 7/ 1 x 15) litres
 - incl. individual lid
 - total height 265 mm
 - optional complete lid can be mounted behind the upper front to save space
 - base tray 562 x 500 mm (W x D), can be cut to size

8011713 orion grey, H 265 mm **94.12 €**

Optional accessories

8011718 Pullboy Versa complete lid, 500 mm, orion grey, powder-coated **56.30 €**

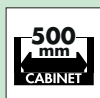
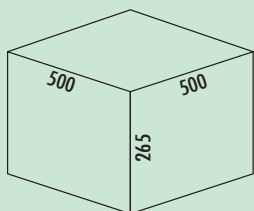
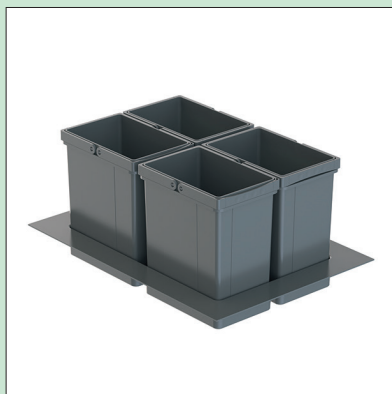

Pullboy Versa 265 S/500-4

- For mounting on existing pull-outs with a nominal depth of 500 mm.
- minimum installation depth (internal dimension of the drawer) 500 mm
 - waste volume 25 (4 x 7) litres
 - incl. individual lid
 - total height 265 mm
 - optional complete lid can be mounted behind the upper front to save space
 - base tray 562 x 500 mm (W x D), can be cut to size

8011712 orion grey, H 265 mm **103.36 €**

Optional accessories

8011718 Pullboy Versa complete lid, 500 mm, orion grey, powder-coated **56.30 €**

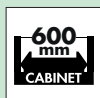
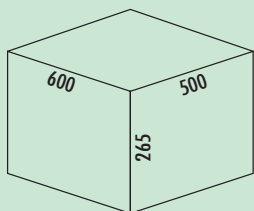
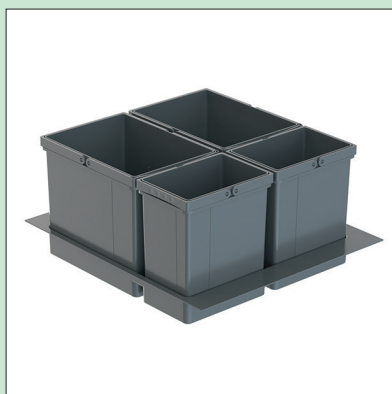

Pullboy Versa 265 S/600-4

- For mounting on existing pull-outs with a nominal depth of 500 mm.
- minimum installation depth (internal dimension of the drawer) 500 mm
 - waste volume 44 (2 x 7/ 2 x 15) litres
 - incl. individual lid
 - total height 265 mm
 - optional complete lid can be mounted behind the upper front to save space
 - base tray 562 x 500 mm (W x D), can be cut to size

8011717 orion grey, H265 mm **119.33 €**

Optional accessories

8011719 Pullboy Versa complete lid, 600 mm, orion grey, powder-coated **59.66 €**

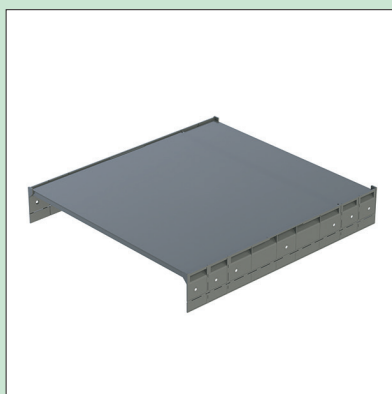

Pullboy Versa complete lid

- Powder-coated metal lid for installation depths of 400 and 500 mm for optional mounting.
- height 20 mm
 - by removing the rear element, the lid can be shortened from 500 to 400 mm and fitted behind the upper front to save space
 - Side attachment rails can be shortened from 500 to 400 mm by means of predefined breaking points

8011718 500 mm, orion grey, powder-coated **56.30 €**

8011719 600 mm, orion grey, powder-coated **59.66 €**

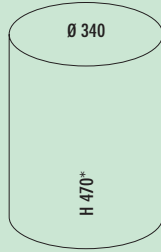

Rondo 2

- waste capacity 13 liters
- technology: swivel technology
- fitting: cabinet wall
- height 470 mm incl. open lid
- a door opening angle of 110° is required

8011005	stainless steel	75.21 €
8011006	white	58.40 €
8011206	silver	58.40 €

Optional accessories

8011318	Console for corner cabinet, aluminium grey NEW!	15.88 €
---------	--	---------

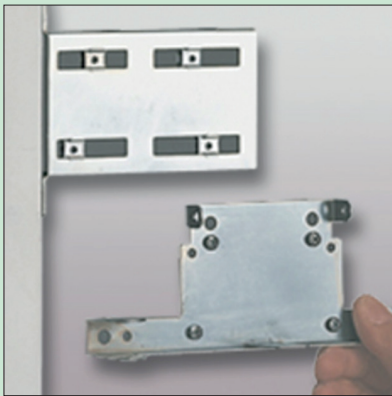

Console for corner cabinet **NEW!**

Adapter. For sink corner base cabinets with central post.

8011318	aluminium grey	15.88 €
---------	----------------	---------

Expected to be available from November 2024.

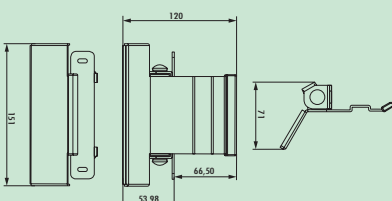

Pedal

Retrofittable for all self-retracting waste collectors with dampers.

- min. 90 mm base height
- min. 60 mm gap between cupboard bottom and insert or pull-out

Accessoires suitable for all waste collectors in the range pull-out technology with front pull-out.

8011187	stainless steel	48.99 €
---------	-----------------	---------

MEC converter system

Smart Home Lighting 2.0 –
perfectly simple, simply perfect!

Innovative light control with clear structure and countless options

Light control next level! With the **Naber MEC converter system**, jumbled cables and wireless connections for individual room lighting design are a thing of the past. Because the **MEC converter** and the **MEC modules** make even complex control solutions for attractive lighting extremely simple and space-saving!

It sounds promising at first: combining and controlling different lights or groups of lights in the kitchen and other rooms as required. However, the more lights are integrated and the more attractive lighting scenarios are required, the harder it is to keep a clear overview.

But the **MEC converter system** tidies things up! **MEC** is a modular power supply and control system for LED lighting. It creates order for modules and connections.

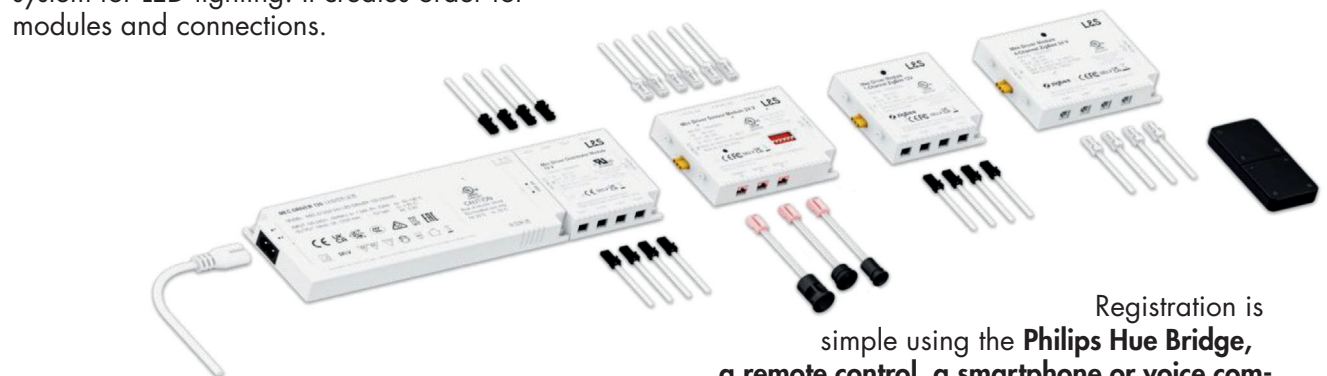

One or more function modules are plugged into the **converter available with four power levels** in order to switch lighting as desired via various sensors, a remote control or even a smart home system. Perfect and simple!

Because the **MEC converter** can output both 12 and 24 volts via the pluggable function modules, **for the first time both voltages can be sup-**



plied via a single converter. Thanks to the freely combinable modules connected in series, the **MEC converter system** offers a wide range of individual lighting solutions.

The MEC system is also **extremely compatible.** Because, in addition to control via a 4-channel ZigBee remote control, the MEC system can also be combined with existing LED lights. The simple registration of lights in the current Zigbee 3.0 standard allows Naber LED lights from the LUMICA® LIC range to be controlled **together with existing living room lights from other manufacturers.**

Registration is simple using the **Philips Hue Bridge, a remote control, a smartphone or voice command.** Everything is clearly connected, quickly and safely set up and, above all, **very easy to operate!**

All Naber lights with this symbol can be combined with each other and controlled via the converters and function modules, or can also be operated as individual lights.

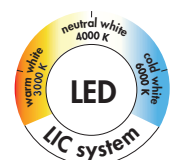

MEC converter system

Smart Home Lighting 2.0 – system components

A. Naber components



Converter

Modular power supply and control system for LED lighting, 12 V and 24 V, power 18 to 120 W.



Light(s)

All Naber lights with the LIC LED system symbol



Modules



Verteilermodule, 12/24 V

8 outputs, standard configuration. For connecting up to 8 lights.



Switching module, 12/24 V

For switching up to 3 light groups via wired sensors



1- or 4-channel radio/ZigBee module, 12/24 V

For connecting up to 4 lights or groups of lights, with control via remote control, smartphone or smart home ZigBee 3.0 network.



Wired sensors

For connection to the switching module.



Sensor IR/door contact



Motion detector



Switch on/off

Connecting cable

Optional accessories



MEC converter connection cable, 100 mm, 12/24 volt

Remote control



Remote control 1-channel or 4-channel



Stepless or gradual adjustment of colour temperature and dimming. Simple integration into ZigBee 3.0 smart home applications. Colours: black or white.

B. On-site components



Smart speaker

e.g. Amazon Echo Dot 4, Google Home



ZigBee Bridge

e.g. Philips Hue



Internet router

Commercially available Internet router (e.g. AVM Fritz!Box)

The functioning of the LUMICA® MEC 1- or 4-channel radio/ZigBee module with Amazon Alexa and Google Assistant as well as the Philips Hue Bridge was tested at the time this catalogue page was created. We have no control over any changes or further development of the apps carried out since then. We make no claim to the accuracy and completeness of the information. Other intelligent personal assistants (IPA, voice assistants) can also be used. Please observe the instructions for use of the respective provider. – **Not compatible with Apple HomeKit!**

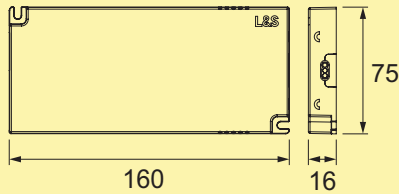
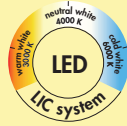

MEC Driver LED converter

NEW!

- white
- 12/24 VDC
- 2000 mm mains connection line
- connection values (watt) of the individual converters are to be observed (watt)

7061400	18 W, 12/24 V	35.38 €
7061401	36 W, 12/24 V	51.09 €
7061403	60/72 W, 12/24 V	96.72 €
7061405	120 W, 24 V	134.62 €

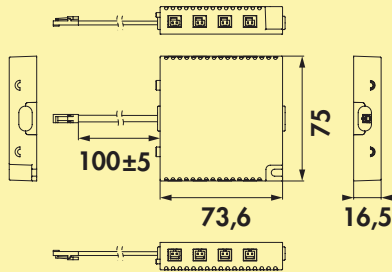
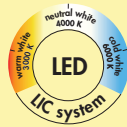

MEC Driver LED distributor module

NEW!

- white
- 12/24 VDC, max. 3 A per outlet, max. 5 A total
- 8 LED outlets

7061407		21.68 €
7061408		21.43 €

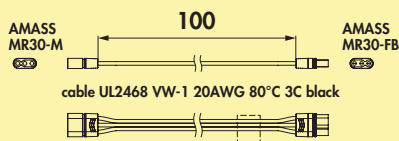
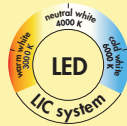

MEC Driver LED connecting line

NEW!

- For flexible connection of converters and function modules.
- black
 - 12/24 V, 5 A

7061409	L 100 mm	6.72 €
----------------	----------	---------------

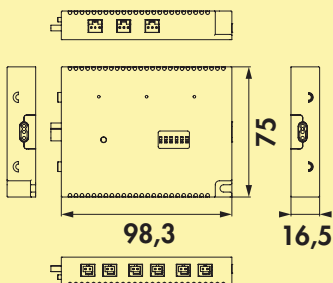
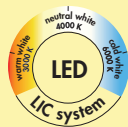
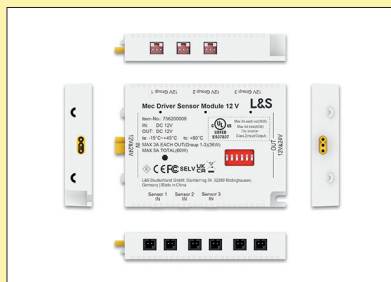

MEC Driver LED switching module

NEW! CE

- white
- max. 3 A per outlet, max. 5 A total
- control via wired and/or wireless sensors (IR, capacitive or motion detectors)
- 3 light groups with 2 LED outlets each
- group switching (3 groups) or cross switching of the LED outlets
- light colour can be set using the DIP switch (Emotion light required)

7061412	12 V	97.31 €
7061413	24 V	97.31 €

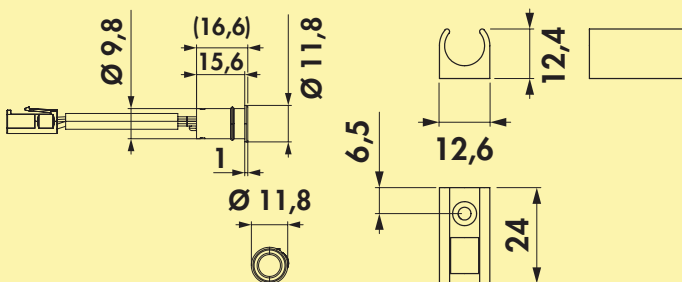
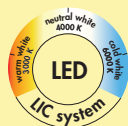

MEC Driver LED sensor IR/door contact

NEW! CE

- black
- use with the MEC Driver switching module
- dimmer or door contact function, depending on the function module setting
- setting of the run-on time via the function module
- range max. 50 mm
- connection line 2000 mm

7061414	sensor	11.68 €
7061415	attachment housing	4.54 €

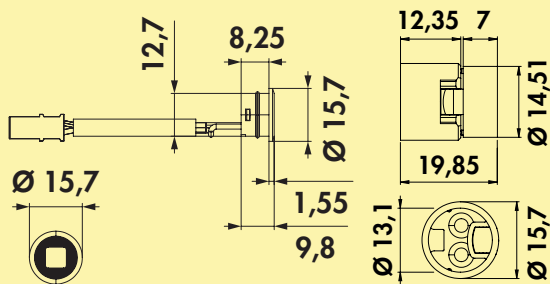
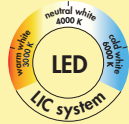

MEC Driver LED motion detector

NEW! CE

- black
- use with the MEC Driver switching module
- setting of the run-on time via the function module
- 2000 mm connection line

7061416	motion detector	27.98 €
7061417	attachment housing	8.99 €

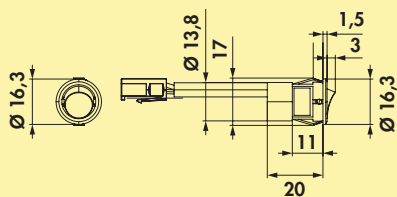
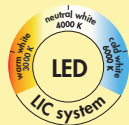

MEC Driver LED switch

NEW! CE

- wired
- ON/OFF switch for the MEC LED Driver switching module
- 2000 mm connection line

7061419	black	14.37 €
---------	-------	---------

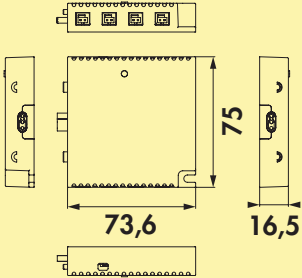
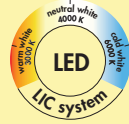

MEC Driver LED 1-channel module radio/ZigBee



NEW!

- white
- 1-channel, 4 LED outlets
- max. 3 A per outlet, max. 5 A total
- control by remote control or smart home
- ZigBee Mesh also without a bridge (components connect to each other)
- simple familiarisation
- can be switched between emotion and single colour LEDs

7061426 12 V	59.58 €
7061427 24 V	64.12 €

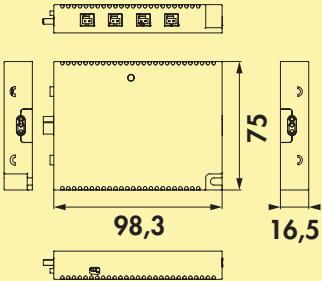
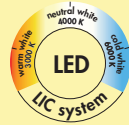

MEC Driver LED 4-channel module radio/ZigBee



NEW!

- white
- 4-channels with one LED outlet each
- max. 3 A per outlet, max. 5 A total
- control by remote control or smart home
- ZigBee Mesh also without a bridge (components connect to each other)
- simple familiarisation
- can be switched between emotion and single colour LEDs

7061428 12 V	83.78 €
7061429 24 V	83.78 €

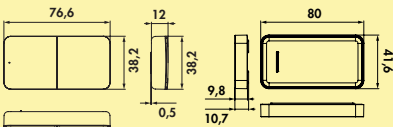
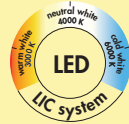

MEC Driver LED remote control 1+4 channel ZigBee



NEW!

- 4 channels
- control of LIC system LED lights via 1-channel and 4-channel module
- stepless control of the colour temperature and dimming level
- easy integration into existing ZigBee network

7061430 black	62.77 €
7061431 white	62.77 €

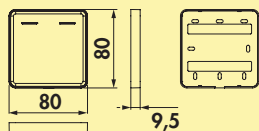

MEC Driver LED mounting plate

NEW! CE

— holder for **two** remote controls

7061432	black	6.05 €
7061433	white	6.05 €

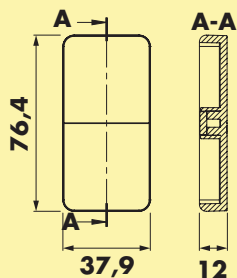

MEC Driver LED blind cover

NEW! CE

— for MEC Driver LED mounting plate
— for mount for two remote controls

7061434	black	4.20 €
7061435	white	4.20 €



NEW!

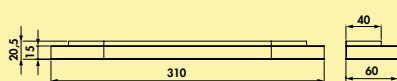
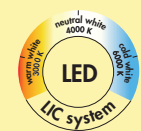

Sun Beam colour change LED

CE

Lamp for mounting from below. Plastic housing with glass, illumination without visible LED spots.

Individual lamp without switch

- 5.6 watt, 12 V.
- stepless control of the light colour from **2200 K** warm white to **6500 K** cold white
- very high light quality thanks to colour rendering index > 90
- optimal illumination of the work area through innovative lens optics technology and asymmetrical light
- memory function: the last setting is saved
- dimming function: brightness continuously dimmable
- max. 129 lumen/watt at **6500 K** cold white
- 1500 mm supply line, 350 mm connecting line
- LIC LED system compatible

This product contains a light source with the energy efficiency class E + F. Further colour change function converters and remote controls can be found in catalogue 1 page 268–270/24 EN.

7064335	black matt	80.08 €
---------	------------	---------

Expected to be available from November 2024.

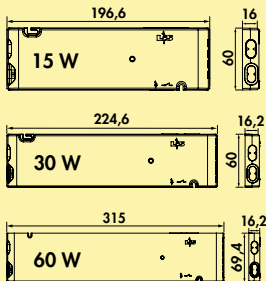
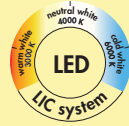

FW function converter



The FW function converter for colour change lighting systems.

- white
- 12 VDC
- max. 36 watt load per slot on the converter
- 2000 mm mains connection line
- **switchable by Bluetooth app (module 3) or by optionally available radio remote control**

7061286 module 2 (radio), 15 W, 4-way distributor	95.21 €
7061271 module 2 (radio), 30 W, 6-way distributor	121.26 €
7061273 module 2 (radio), 60 W, 6-way distributor	152.69 €
7061287 module 3 (Bluetooth + radio), 15 W, 4-way distributor	127.56 €
7061281 module 3 (Bluetooth + radio), 30 W, 6-way distributor	156.30 €
7061283 module 3 (Bluetooth + radio), 60 W, 6-way distributor	188.66 €

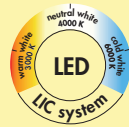

1-channel colour change remote control



- stepless control of the light colour
- dimming function
- auto memory: brightness and light temperature settings are saved
- one controller can be used for various colour change converters
- 8 x 90 x 50 mm (H x L x B)

7061285 white	53.61 €
----------------------	----------------



230 volt connecting line



For connecting several FW function converters.

7061284 L 300 mm, white	3.28 €
--------------------------------	---------------



Distributor 6-fold

- for 12 VDC
- with 200 mm of supply line

7061244 black	6.97 €
----------------------	---------------

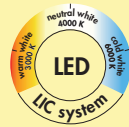
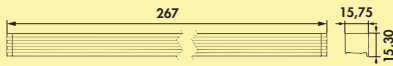
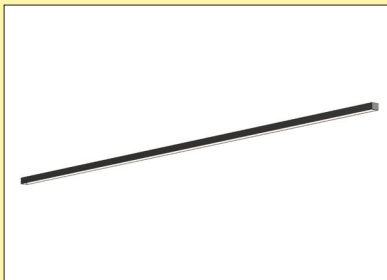

Brillante colour change LED



Lamp for mounting from below. Powder coated aluminium profile, with plastic cover black matt incl. LED Stripe.

Individual lamp without switch

- 12 VDC
- stepless control of the light colour from **2200 K** warm white to **6500 K** cold white
- very high light quality thanks to colour rendering index > 90
- optimal illumination of the work area through innovative lens optics technology and asymmetrical light
- max. 129 lumen/watt at **6000 K** cold white
- 2000 mm supply line
- LIC LED system compatible

This product contains a light source with the energy efficiency class E.

Further colour change function converters and remote controls can be found in catalogue 1 page 268–270/24 EN.

7064340	L 267 mm, 3.8 W	54.62 €
7064341	L 367 mm, 5.3 W	68.07 €
7064342	L 467 mm, 6.9 W	76.47 €
7064343	L 567 mm, 8.4 W	83.19 €
7064344	L 767 mm, 11.5 W	105.88 €
7064345	L 867 mm, 12.9 W	116.81 €
7064346	L 967 mm, 14.5 W	129.41 €
7064347	L 1167 mm, 17.6 W	142.02 €

Expected to be available from November 2024.

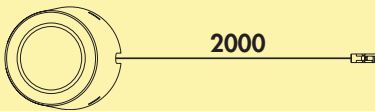
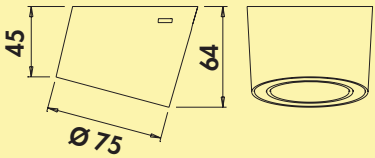

Unika 1 colour change LED



Surface mounted lamp. Plastic body, round, Illumination without visible LED points.

- 4,5 watts, 24 V
- Setting of the light colour to **2700 K** warm white or **3900 K** neutral white (only in conjunction with Unika 2 LED touch switch and dimmer, 7063369)
- memory function: the last setting is stored
- dimmer function: brightness continuously dimmable
- max. 80 lumen/watt
- 2000 mm supply line
- connection to LED converter (7062250 or 7062251)

This product contains a light source with the energy efficiency class E.

7063368 individual lamp without switch, black matt	65.55 €
7063381 individual lamp without switch, stainless steel col. NEW!	65.55 €

Optional accessories

7062252 LED connection line 24, white, L 2000 mm	4.71 €
---	---------------

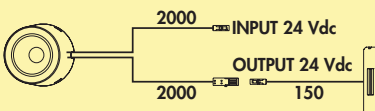
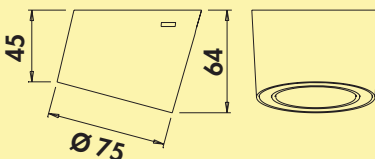
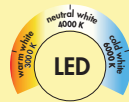

Unika 2 colour change LED



Surface mounted lamp. Plastic body, round, Illumination without visible LED points with **integrated** touch switch.

Individual lamp with LED Touch switch and dimmer (w. LED Touch s. d.)

- 4,5 watts, 24 V
- setting of the the light colour to **2700 K** warm white or **3900 K** neutral white
- memory function: the last setting is stored
- dimmer function: brightness continuously dimmable
- max. 80 lumen/watt
- 2000 mm supply line
- connection to LED converter (7062250 or 7062251)

This product contains a light source with the energy efficiency class E.

7063369 single lamp w. LED Touch s. d., black matt	126.05 €
7063382 single lamp w. LED Touch s. d., stainless steel col. NEW!	126.05 €

Optional accessories

7062252 LED connection line 24, white, L 2000 mm	4.71 €
---	---------------

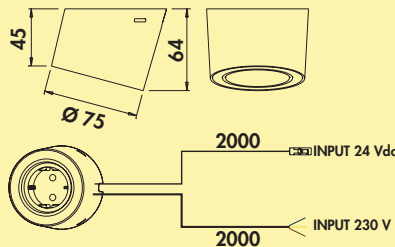
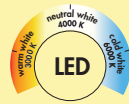

Unika 3 colour change LED



Surface mounted lamp. Plastic body, round, illumination without visible LED points with **integrated** socket.

- 4,5 watts, 24 V
- setting of the light colour to **2700 K** warm white or **3900 K** neutral white (only in combination with Unika 2 LED Touch switch and dimmer 7063369)
- memory function: the last setting is stored
- dimmer function: brightness continuously dimmable
- max. 80 lumen/watt
- socket 240 V/16 A
- 2000 mm supply line
- connection to LED converter (7062250 or 7062251)

This product contains a light source with the energy efficiency class E.

7063370 single lamp with earthed plug sockets, black matt **101.68 €**

7063383 single lamp with earthed plug sockets, stainless steel col. **NEW!** **101.68 €**

Optional accessories

7062252 LED connection line 24, white, L 2000 mm **4.71 €**



Unika 5 colour change LED



Surface-mounted lamp. Plastic housing, round, illumination without visible LED spots, with **integrated** double USB charger.

- lamp 4.5 watt, 24 V
- USB 20 watt, 24 V
- setting of the light colour to **2700 K** warm white or **4000 K** neutral white (only in combination with Unika 2 LED Touch switch and dimmer, 7063369)
- memory function: the last setting is saved
- dimming function: brightness continuously dimmable
- max. 80 lumen/watt
- 2 X USB charger type C, 5 VDC, 1A I out: 2 x 1000 mA
- 2000 mm supply line, 2 x 24 V
- connection to LED converter (7062250 or 7062251)

This product contains a light source with the energy efficiency class E.

Please bear in mind the 20 watt charger capacity at the converter!

7063380 luminaire individuel avec 2-fold USB C, black matt **123.95 €**

7063384 luminaire individuel avec 2-fold USB C, stainless-steel coloured **123.95 €**

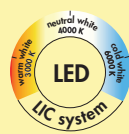

Anelli colour change LED 2



Built-in lamp. Aluminium body. Illumination without visible LED points.

Individual lamp without switch

- 2,5 watts, **24 V**
- continuous control of the light colour from **2700 K** warm white to **6500 K** cold white
- dimmer function: brightness continuously dimmable
- max. 108 lumen/watt at **6500 K** cold white
- 1800 mm supply line
- drill Ø 68 mm
- installation depth 14 mm

This product contains a light source of energy efficiency class D.

You can find the appropriate colour change function converters and remote controls here in the MEC Driver LED system.

7061374 individual lamp without switch, stainless-steel coloured	46.22 €
7061375 individual lamp without switch, black matt	46.22 €
Optional accessories	
7061376 Anelli mounting ring 2, stainless steel coloured, 13 mm	5.88 €
7061377 Anelli mounting ring 2, matt black, 13 mm	6.72 €
7061378 LED connection line, white	4.79 €

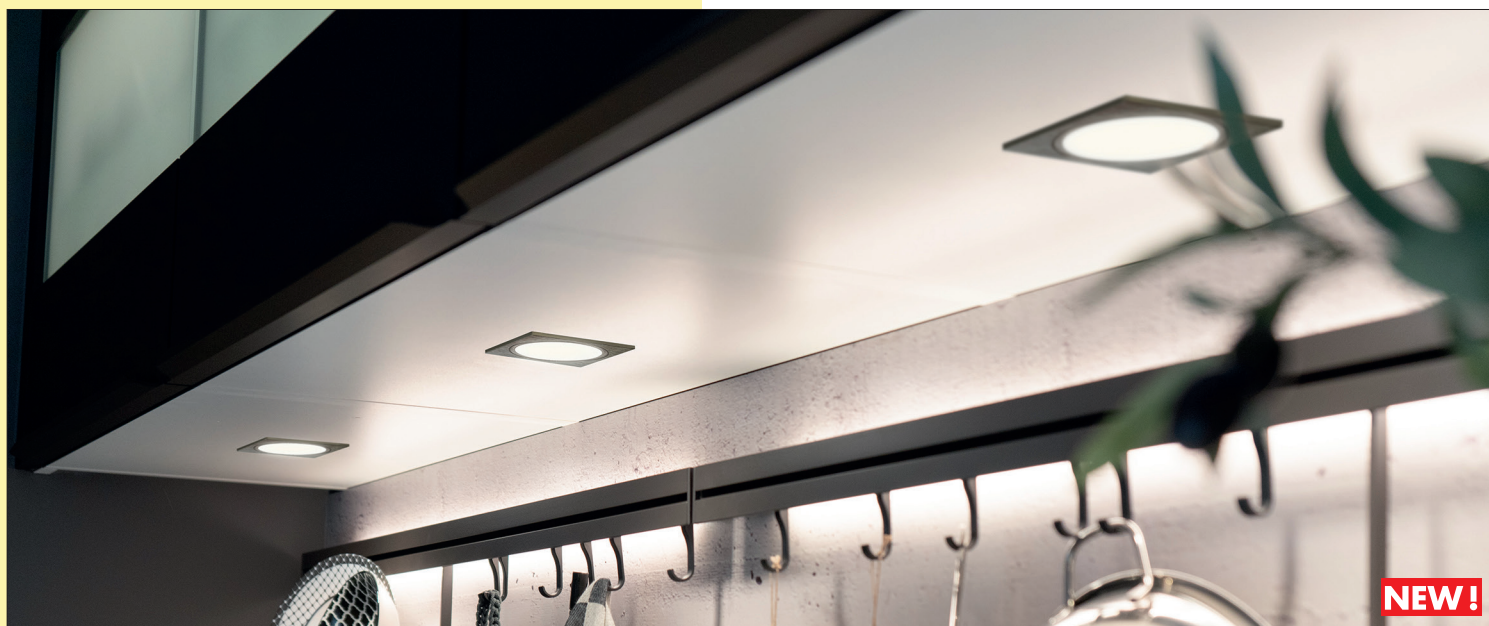

NEW!

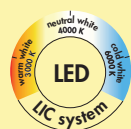

Anelli colour change LED 3



Built-in lamp. Aluminium body. Illumination without visible LED points.

Individual lamp without switch

- 2,5 watts, 24 V
- continuous control of the light colour from 2700 K warm white to 6500 K cold white
- dimmer function: brightness continuously dimmable
- max. 119 lumen/watt at 6500 K cold white
- 1800 mm supply line
- drill Ø 68 mm
- installation depth 14 mm

This product contains a light source of energy efficiency class D.

You can find the appropriate colour change function converters and remote controls here in the MEC Driver LED system.

7061370	individual lamp without switch, stainless steel coloured	38.66 €
7061371	individual lamp without switch, black matt	38.66 €
Optional accessories		
7061372	Anelli mounting ring 3, stainless steel coloured, 15 mm	7.14 €
7061373	Anelli mounting ring 3, matt black, 15 mm	9.24 €
7061378	LED connection line, white	4.79 €

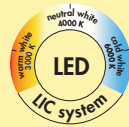

Andy colour change LED



Handle strip lighting. Aluminium housing with plastic corners. LED strip moulded in silicone, **non-self-adhesive**, can be shortened every 21 mm. Illumination without visible LED spots incl. mounting clips for handle strips.

Individual lamp

- 6.5 watt per meter, 12 V
- stepless control of the light colour from **2700 K** warm white to **6500 K** cold white
- max. 80 lumen/watt at **6500 K** cold white
- LED strip, feed from both sides
- 2000 mm supply line on both sides
- incl. 4 end caps (2 x left, 2 x right)
- incl. 8 clips (2 x 4 pieces)

This product contains a light source with the energy efficiency class G.

The matching colour change function converters and remote controls for individual lamps without switches can be found in catalogue 1 page 268–270/24 EN.

7063400 single lamp, L 1000 mm, stainless steel coloured	116.97 €
7063401 single lamp, L 1000 mm, black	121.01 €
7063402 single lamp, L 2000 mm, stainless steel coloured	181.01 €
7063403 single lamp, L 2000 mm, black	186.05 €

Optional accessories

7063406 Andy internal corners, stainless-steel coloured	4.54 €
7063407 Andy internal corners, black	4.54 €
7063404 Andy external angle, stainless-steel coloured	11.26 €
7063405 Andy external angle, black	11.26 €

Expected to be available from December 2024.



Andy end caps set

Set consisting of:

- 4 x end caps (2 x left, 2 x right)

7063410 stainless-steel coloured	12.44 €
7063411 black	12.44 €

Expected to be available from December 2024.

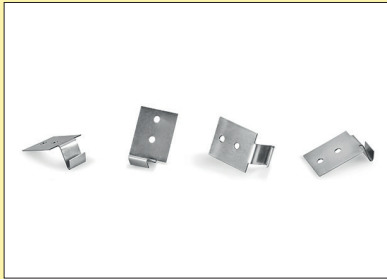

Andy mounting clips

Set consisting of:
– 2 x 4 clips

7063409

12.44 €

Expected to be available from December 2024.



LED connection line

CE

– secondary for LED
– with mini plug-in system

7061049 white, L 2000 mm

4.03 €

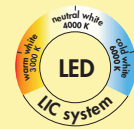

Andy colour change LED strip

F M M CE

Flexible LED strips. LED moulded in silicone. For Andy handle strip lighting.
This product contains a light source with the energy efficiency class G.

7063408 L 2000 mm, 13 W/12 V

112.61 €

Expected to be available from December 2024.

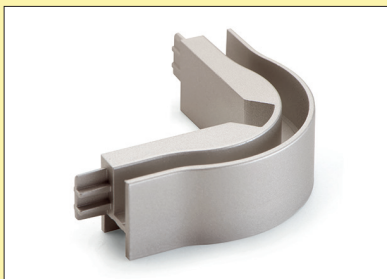

Andy external angle

Plastic.

7063404 stainless-steel coloured

11.26 €

7063405 black

11.26 €

Expected to be available from December 2024.



Andy internal corners

Plastic.

7063406 stainless-steel coloured

4.54 €

7063407 black

4.54 €

Expected to be available from December 2024.

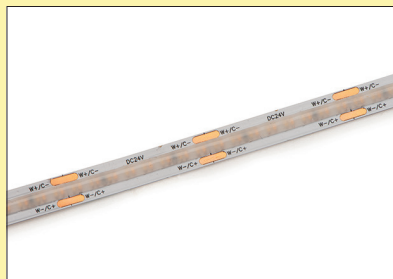
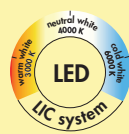

LED strip COB FW



Flexible LED strips. Ambient light.

Flex Stripes

- 8 watt per meter, 12 VDC.
- stepless control of the light colour from **2700 K** warm white to **6500 K** cold white
- max. 100 lumen/watt at **6000 K** cold white
- 2000 mm supply line on both sides

This product contains a light source with the energy efficiency class F.

The matching colour change function converters and remote controls can be found in catalogue 1 page 268–270/24 EN.

7063417	L 1500 mm, white	60.50 €
7063416	L 2600 mm, white	91.60 €

Expected to be available from November 2024.

NEW!

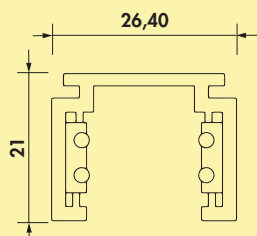

Easytrack rail

CE

Low-voltage busbar. Powder-coated aluminium housing. Can be cut to size.
 – 48 VDC
 – pre-drilled mounting holes for quick installation
 – safe installation and operation thanks to protective extra-low voltage (SELV 48 V)

7065077	L 1000 mm, black matt	59.41 €
7065078	L 1500 mm, black matt	83.70 €
7065079	L 2000 mm, black matt	111.60 €

Expected to be available from November 2024.

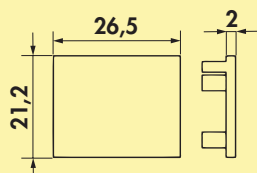
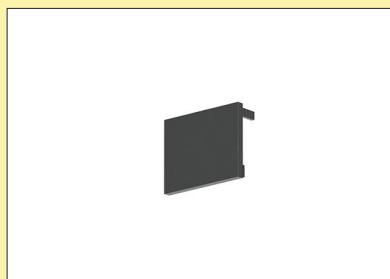

Easytrack end caps

CE

Plastic end caps for closing the front end of the Easytrack busbar.
 – 21.2 x 26.5 mm (H x D)
 – available only in PU of 2 pc.

7065080	black matt	3.82 €
---------	------------	--------

Expected to be available from November 2024.

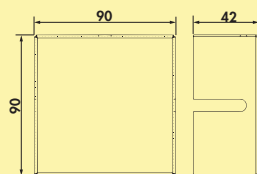
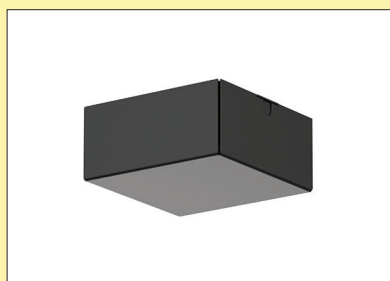

Easytrack connection box

CE

Connection box for Easytrack busbar.
 – powder-coated sheet steel
 – power supply 100 or 200 W
 – ceiling outlet 240 V to 48 V
 – 42 x 90 x 90 mm (H x W x D)
 – can be used as single-sided or double-sided feed-in (only in combination with flexible longitudinal connector)

7065081	black	85.55 €
---------	-------	---------

Expected to be available from November 2024.

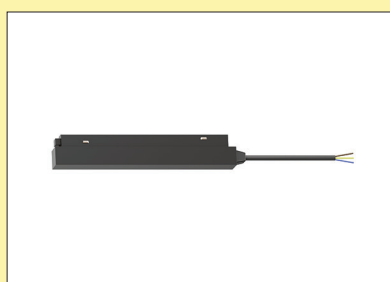

Easytrack power supply

CE

Power supply for Easytrack busbar.
 – plastic
 – 100 or 200 watt
 – 23 x 26 mm (H x W)
 – clip-in mounting

Only use in combination with the connection box!

7065085	black, T 249,6 mm, 100 W	102.61 €
7065086	black, T 305 mm, 200 W	117.90 €

Expected to be available from November 2024.

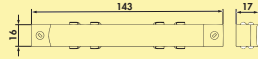

Easytrack longitudinal connector



Longitudinal connector for Easytrack to extend the busbar.

- plastic
- 17 x 16 x 143 mm (H x W x D)
- clip-in mounting

7065082 black

26.89 €

Expected to be available from November 2024.

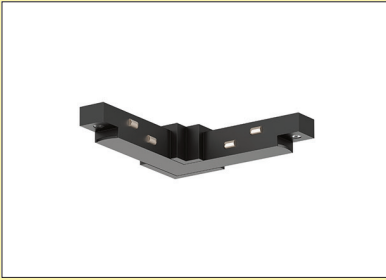

Easytrack L-connector



L-connector for Easytrack busbar.

- plastic
- 21 x 99.5 x 99.5 mm (H x W x D)
- clip-in mounting

7065083 black

26.89 €

Expected to be available from November 2024.



Easytrack T-connector



T-connector for Easytrack busbar.

- plastic
- 18 x 227 x 122 mm (H x W x D)
- clip-in mounting

7065084 black

50.00 €

Expected to be available from November 2024.

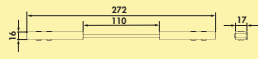
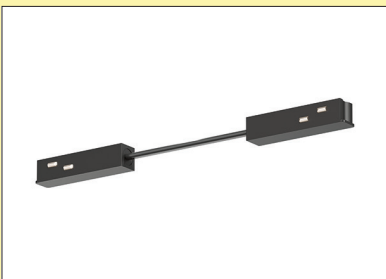

Easytrack flexible connector



Flexible longitudinal connector. To extend the busbar if there is a connection box in between.

- plastic
- 17 x 16 x 272 mm (H x W x D)
- clip-in mounting

7065087 black

34.20 €

Expected to be available from November 2024.

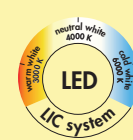

Easytrack pendant S



Pendant light. Pendant S for Easytrack busbar. Powder-coated aluminium housing.

- 5 watt, 48 VDC
- L 300 mm, Ø 30 mm
- stepless control of the light colour from 2700 K warm white to 6000 K cold white
- very high light quality thanks to colour rendering index > 90
- max. 70 lumen/watt at 6000 K cold white
- pendant length incl. light continuously adjustable from 400 mm to 1600 mm
- with integrated ZigBee 3.0 controller

This product contains a light source with the energy efficiency class F.

Tool-free click-in installation in the track. Held in place by a magnet or by additional mechanical locking!

7065074 black matt

221.43 €

Expected to be available from November 2024.

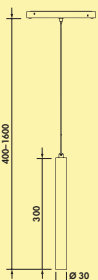

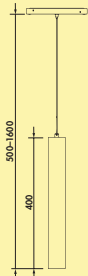
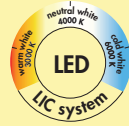
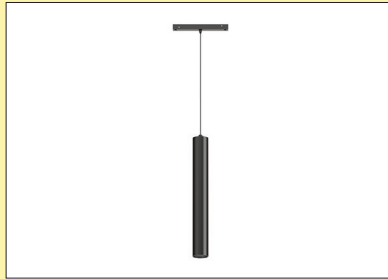

Easytrack pendant M



Pendant light. Pendant M for Easytrack busbar. Powder-coated aluminium housing.

- 10 watt, 48 VDC
- L 400 mm, Ø 52 mm
- stepless control of the light colour from **2700 K** warm white to **6000 K** cold white
- very high light quality thanks to colour rendering index > 90
- max. 92 lumen/watt at **6000 K** cold white
- pendant length incl. light continuously adjustable from 500 mm to 1600 mm
- with integrated ZigBee 3.0 controller

This product contains a light source with the energy efficiency class F.

Tool-free click-in installation in the track. Held in place by a magnet or by additional mechanical locking!

7065075 black matt **241.18 €**

Expected to be available from November 2024.

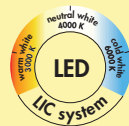

Easytrack pendant G



Pendant light. Pendant Glass for Easytrack busbar. Aluminium housing powder coated, opal white glass globe.

- 5 watt, 48 VDC
- stepless control of the light colour from **2700 K** warm white to **6000 K** cold white
- very high light quality thanks to colour rendering index > 90
- max. 144 lumen/watt at **6000 K** cold white
- pendant length incl. light 1100 mm (not adjustable)
- with integrated ZigBee 3.0 controller

This product contains a light source with the energy efficiency class D.

Tool-free click-in installation in the track. Held in place by a magnet or by additional mechanical locking!

7065076 black matt **253.78 €**

Expected to be available from November 2024.

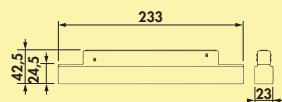
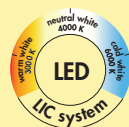
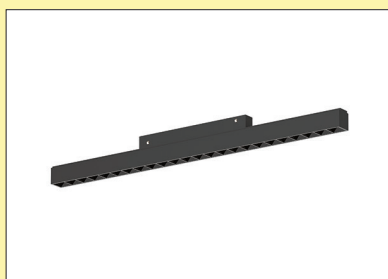

Easytrack linear Light



Linear light for Easytrack busbar. Powder-coated aluminium housing.

- 48 VDC
- stepless control of the light colour from **2700 K** warm white to **6000 K** cold white
- very high light quality thanks to colour rendering index > 90
- max. 144 lumen/watt at **6000 K** cold white
- strong glare-free light (optical lenses) in modern raster optics
- Ideal for illuminating work surfaces (e.g. cooking island)
- with integrated ZigBee 3.0 controller

This product contains a light source with the energy efficiency class D.

Tool-free click-in installation in the track. Held in place by a magnet or by additional mechanical locking!

7065072 L 233 mm, 9.1 W, black matt **224.54 €**

7065073 L 460 mm, 18.1 W, black matt **255.55 €**

Expected to be available from November 2024.

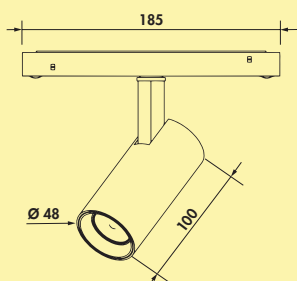

Easytrack Spot



- Spotlight for Easytrack busbar. Powder-coated aluminium housing.
- 8.5 watt, 48 VDC
 - stepless control of the light colour from **2700 K** warm white to **6000 K** cold white
 - very high light quality thanks to colour rendering index > 90
 - max. 92 lumen/watt at **6000 K** cold white
 - rotating and swivelling
 - ideal for accentuation or functional lighting
 - light angle 24°
 - with integrated ZigBee 3.0 controller

This product contains a light source with the energy efficiency class F.

Tool-free click-in installation in the track. Held in place by a magnet or by additional mechanical locking!

7065070 black matt **211.09 €**

Expected to be available from November 2024.

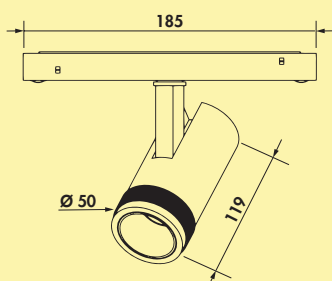
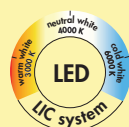

Easytrack ZOOM Spot



- Spotlight Zoom for Easytrack busbar. Powder-coated aluminium housing.
- 10.5 watt, 48 VDC
 - stepless control of the light colour from **2700 K** warm white to **6000 K** cold white
 - very high light quality thanks to colour rendering index > 90
 - max. 92 lumen/watt at **6000 K** cold white
 - rotating and swivelling
 - in addition, the beam angle can be continuously adjusted from 15–55°
 - ideal for accentuation or functional lighting
 - with integrated Zigbee 3.0 controller

This product contains a light source with the energy efficiency class F.

Tool-free click-in installation in the track. Held in place by a magnet or by additional mechanical locking!

7065071 black matt **269.58 €**

Expected to be available from November 2024.

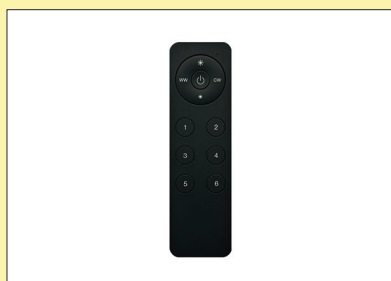

Easytrack remote control



- ZigBee 3.0
- Touchlink
- 6 channels

7064338 black **76.47 €**

Expected to be available from November 2024.

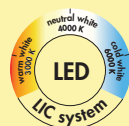

Expected to be available from November 2024.

Easytrack set Akzent



Easytrack rail system 2000 mm, 3 lights, black matt.

Set consisting of:

- 1 Easytrack rail 2000 mm, 7065079
- 1 Easytrack power supply, 7065085
- 1 Easytrack connection box, 7065081
- 1 Easytrack remote control, 7064338
- 1 Easytrack end caps, 7065080
- 3 Easytrack spotlights, 7065070

7065088 black matt **1003.19 €**

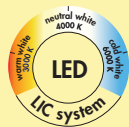

Expected to be available from November 2024.

Easytrack set Dinner



Easytrack rail system 2000 mm, 3 lights, black matt.

Set consisting of:

- 1 Easytrack rail 2000 mm, 7065079
- 1 Easytrack power supply, 7065085
- 1 Easytrack connection box, 7065081
- 1 Easytrack remote control, 7064338
- 1 Easytrack end caps, 7065080
- 3 Easytrack pendant S, 7065074

7065089 black matt

1033.90 €

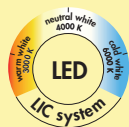

Expected to be available from November 2024.

Easytrack set Dinner Plus



Easytrack rail system 2000 mm, 3 lights, black matt.

Set consisting of:

- 1 Easytrack rail 2000 mm, 7065079
- 1 Easytrack power supply, 7065085
- 1 Easytrack connection box, 7065081
- 1 Easytrack remote control, 7064338
- 1 Easytrack end caps, 7065080
- 3 Easytrack pendant G, 7065076

7065093 black matt

1129.98 €

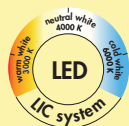

Expected to be available from November 2024.

Easytrack set Cooking pendant



Easytrack rail system 2000 mm, 3 lights, black matt.

Set consisting of:

- 1 Easytrack rail 2000 mm, 7065079
- 1 Easytrack power supply, 7065085
- 1 Easytrack connection box, 7065081
- 1 Easytrack remote control, 7064338
- 1 Easytrack end caps, 7065080
- 3 Easytrack pendant M, 7065075

7065094 black matt

1092.55 €

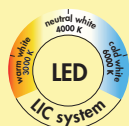
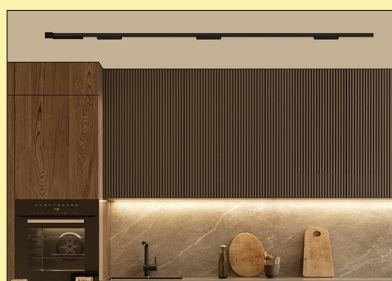

Expected to be available from November 2024.

Easytrack set Cooking Power



Easytrack rail system 2000 mm, 3 lights, black matt.

Set consisting of:

- 1 Easytrack rail 2000 mm, 7065079
- 1 Easytrack power supply, 7065085
- 1 Easytrack connection box, 7065081
- 1 Easytrack remote control, 7064338
- 1 Easytrack end caps, 7065080
- 3 Easytrack linear Light, 7065072

7065095 black matt

1043.13 €

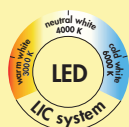

Expected to be available from November 2024.

Easytrack set Akzent Plus



Easytrack rail system 2000 mm, 3 lights, black matt.

Set consisting of:

- 1 Easytrack rail 2000 mm, 7065079
- 1 Easytrack power supply, 7065085
- 1 Easytrack connection box, 7065081
- 1 Easytrack remote control, 7064338
- 1 Easytrack end caps, 7065080
- 3 Easytrack ZOOM Spot, 7065071

7065096 black matt

1176.90 €

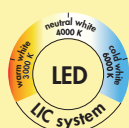
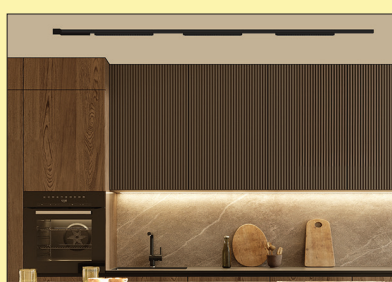

Expected to be available from November 2024.

Easytrack set Cooking Power 2



Easytrack rail system 2000 mm, 3 lights, black matt.

Set consisting of:

- 1 Easytrack rail 2000 mm, 7065079
- 1 Easytrack power supply, 7065085
- 1 Easytrack connection box, 7065081
- 1 Easytrack remote control, 7064338
- 1 Easytrack end caps, 7065080
- 3 Easytrack linear Light, 7065073

7065097 black matt

1135.23 €

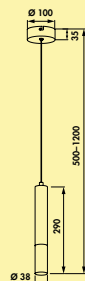

Gwen 1 LED



Pendant light. Aluminium housing. White plastic cover incl. converter.
 – 5 watt, 230 V, two colour ranges: **3000 K** warm white, **4000 K** neutral white
 – max. 120 lumen/watt
 – suspension max. 1200 mm, can be shortened to 500 mm
 – dimensions of the ceiling mounting 100 x 35 mm (Ø x H)
 – dimensions of the lamp 100 x 1200 mm (Ø x H)
 – **cannot be dimmed with an existing dimmer**
 – **without remote control, on/off function using existing light switch**
This product contains a light source with the energy efficiency class F.

7065100 3000 K warm white, stainless-steel coloured	67.56 €
7065101 3000 K warm white, black matt	60.34 €

7065102 4000 K neutral white, stainless-steel coloured	67.56 €
7065103 4000 K neutral white, black matt	60.34 €

Expected to be available from February 2025.

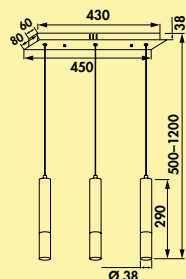

Gwen 3 LED



Pendant light. Aluminium housing. White plastic cover incl. converter.
 – 15 watt, 230 V, two colour ranges: **3000 K** warm white, **4000 K** neutral white
 – max. 120 lumen/watt
 – suspension max. 1200 mm, can be shortened to 500 mm
 – dimensions of the ceiling mounting 38 x 80 x 450 mm (H x W x L)
 – dimensions of the lamp 1200 x 80 x 450 mm (H x W x L)
 – **cannot be dimmed with an existing dimmer**
 – **without remote control, on/off function using existing light switch**
This product contains a light source with the energy efficiency class F.

7065104 3000 K warm white, stainless-steel coloured	184.54 €
7065105 3000 K warm white, black matt	175.55 €

7065106 4000 K neutral white, stainless-steel coloured	184.54 €
7065107 4000 K neutral white, black matt	175.55 €

Expected to be available from February 2025.

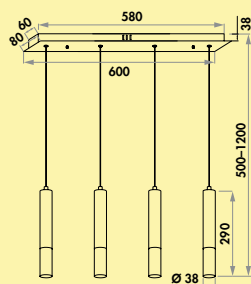

Gwen 4 LED



Pendant light. Aluminium housing. White plastic cover incl. converter.
 – 20 watt, 230 V, two colour ranges: **3000 K** warm white, **4000 K** neutral white
 – max. 120 lumen/watt
 – suspension max. 1200 mm, can be shortened to 500 mm
 – dimensions of the ceiling mounting 38 x 80 x 600 mm (H x W x L)
 – dimensions of the lamp 1200 mm x 80 mm x 600 mm (H x W x L)
 – **cannot be dimmed with an existing dimmer**
 – **without remote control, on/off function using existing light switch**
This product contains a light source with the energy efficiency class F.

7065108	3000 K warm white, stainless-steel coloured	251.09 €
---------	---	----------

7065109	3000 K warm white, black matt	233.11 €
---------	-------------------------------	----------

7065110	4000 K neutral white, stainless-steel coloured	251.09 €
---------	--	----------

7065111	4000 K neutral white, edelstahlfarbig	233.11 €
---------	---------------------------------------	----------

Expected to be available from February 2025.

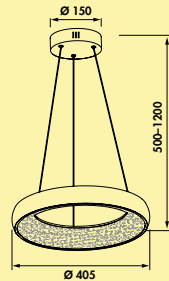
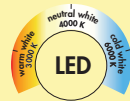

Lima colour change LED



Pendant light. Aluminium housing. White plastic cover incl. converter and remote control (without batteries)

- 24 watt, 230V
- stepless control of the light colour from **3000 K** warm white to **6000 K** cold white
- memory function: the last setting is saved
- dimming function: brightness continuously dimmable
- max. 120 lumen/watt at **6000 K** cold white
- suspension max. 1200 mm, can be shortened to 500 mm
- dimensions of the ceiling mounting 150 x 40 mm (Ø x H)
- dimensions of the lamp 400 x 1200 mm (Ø x H)

This product contains a light source with the energy efficiency class F.

7065112 stainless-steel coloured	280.84 €
7065113 stainless-steel coloured	270.00 €

Expected to be available from February 2025.

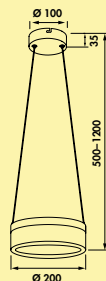
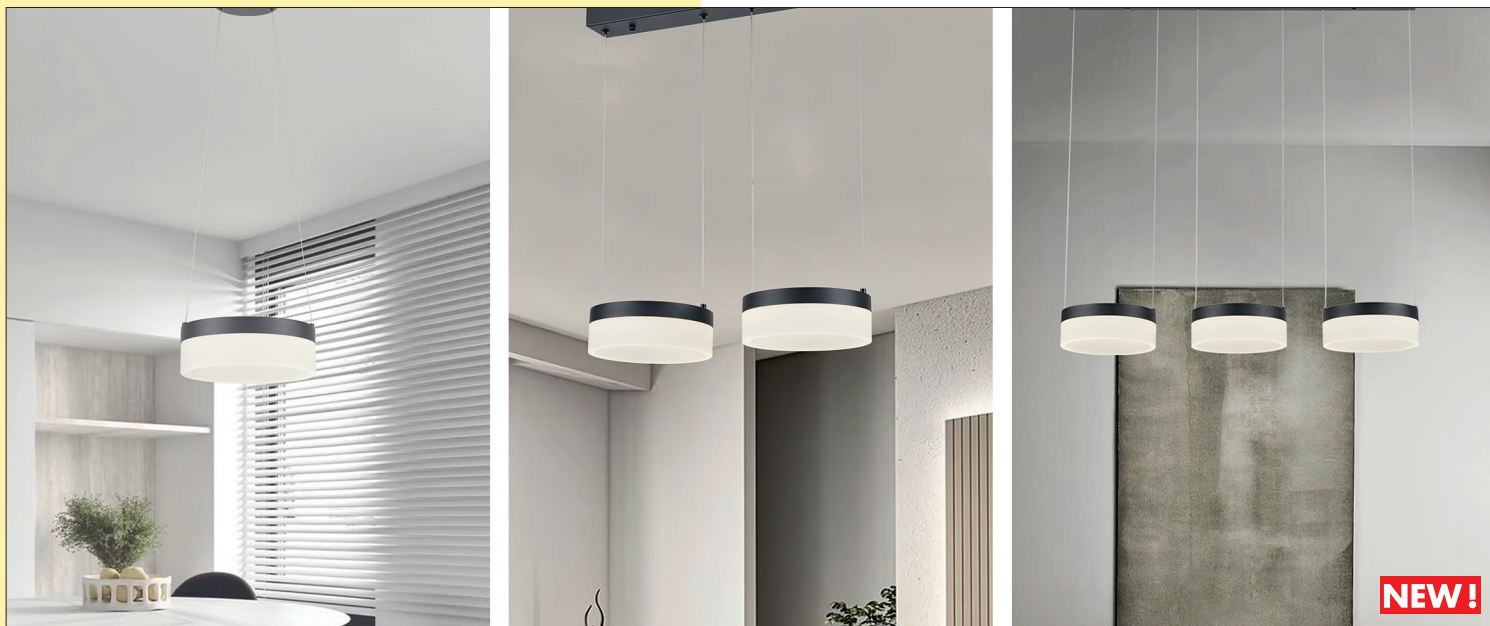

Nicky 1 LED



Pendant light. Aluminium housing. White plastic cover incl. converter.
 – 12 watt, 230 V, two colour ranges: **3000 K** warm white, **4000 K** neutral white
 – max. 120 lumen/watt
 – suspension max. 1200 mm, can be shortened to 500 mm
 – dimensions of the ceiling mounting 100 x 35 mm (Ø x H)
 – dimensions of the lamp 200 x 1200 mm (Ø x H)
 – **cannot be dimmed with an existing dimmer**
 – **without remote control, on/off function using existing light switch**
This product contains a light source with the energy efficiency class F.

7065114 3000 K, warm white, stainless-steel coloured	109.83 €
7065115 3000 K, warm white, black matt	109.83 €
7065116 4000 K, neutral white, stainless-steel coloured	109.83 €
7065117 4000 K, neutral white, matt black	109.83 €

Expected to be available from February 2025.

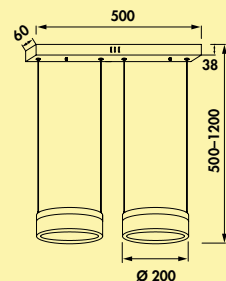

Nicky 2 LED



Pendant light. Aluminium housing. White plastic cover incl. converter.
 – 24 watt, 230 V, two colour ranges: **3000 K** warm white, **4000 K** neutral white
 – max. 120 lumen/watt
 – suspension max. 1200 mm, can be shortened to 500 mm
 – dimensions of the ceiling mounting 38 x 60 x 500 mm (H x W x L)
 – dimensions of the lamp 1200 x 200 x 500 mm (H x W x L)
 – **cannot be dimmed with an existing dimmer**
 – **without remote control, on/off function using existing light switch**
This product contains a light source with the energy efficiency class F.

7065118 3000 K, warm white, stainless-steel coloured	215.13 €
7065119 3000 K, warm white, black matt	202.52 €
7065120 4000 K, neutral white, stainless-steel coloured	215.13 €
7065121 4000 K, neutral white, matt black	202.52 €

Expected to be available from February 2025.

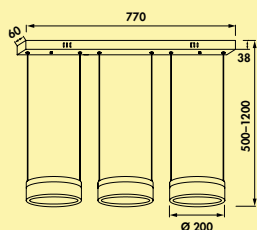

Nicky 3 LED



Pendant light. Aluminium housing. White plastic cover incl. converter.

- 36 watt, 230 V, two colour ranges: **3000 K** warm white, **4000 K** neutral white
- max. 120 lumen/watt
- suspension max. 1200 mm, can be shortened to 500 mm
- dimensions of the ceiling mounting 38 x 60 x 770 mm (H x W x L)
- dimensions of the lamp 1200 x 200 x 770 (H x W x L)
- **cannot be dimmed with an existing dimmer**
- **without remote control, on/off function using existing light switch**

This product contains a light source with the energy efficiency class F.

7065122 3000 K, warm white, stainless-steel coloured **323.11 €**

7065123 3000 K, warm white, black matt **301.51 €**

7065124 4000 K, neutral white, stainless-steel coloured **323.11 €**

7065125 4000 K, neutral white, matt black **301.51 €**

Expected to be available from February 2025.

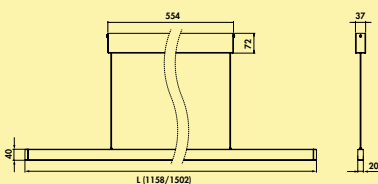
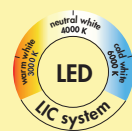

Sun Romo colour change LED



Pendant light. Aluminium housing black matt. Indirect and direct light (separately controllable). Incl. converter and remote control.

- 240 V
- stepless control of the light colour from **2200 K** warm white to **6500 K** cold white
- very high light quality thanks to colour rendering index >90
- memory function: the last setting is saved
- dimming function: brightness continuously dimmable
- **cannot be dimmed with an existing dimmer**
- max. 53 lumen/watt at 6000 K cold white
- suspension max. 1500 mm
- with integrated Zigbee 3.0 controller

This product contains a light source with the energy efficiency class E + F.

7065066 L 1200 mm, 41.5 W **882.02 €**

7065067 L 1500 mm, 55 W **1043.70 €**

Expected to be available from November 2024.

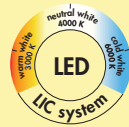
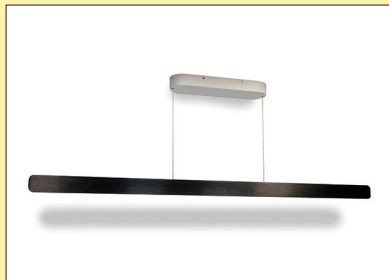

Verste colour change LED



Pendant light. Aluminium housing black. Indirect and direct light incl. converter and remote control.

- 240 V
- stepless control of the light colour from **2700 K** warm white to **6500 K** cold white
- memory function: the last setting is saved
- dimming function: brightness continuously dimmable
- max. 125 lumen/watt at **6500 K** cold white
- suspension of 200–1500mm
- with integrated Zigbee 3.0 controller

This product contains a light source with the energy efficiency class G.

7065090	L 900 mm, 32 W	693.28 €
7065091	L 1200 mm, 42 W	863.87 €
7065092	L 1500 mm, 53 W	1174.79 €

Expected to be available from December 2024.

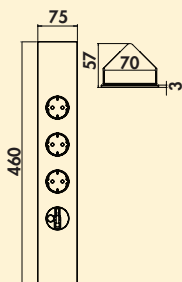

Mira corner glass USB C Snap

NEW! CE

Corner socket element. 3-way and **extendable USB C charging cable**. Practical snap-in and snap-out function of the USB-C plug cable in the housing. Front in printed and scratch-resistant glass, for 90° corner.

- aluminium housing, black
- 230 V/16 A
- 1 x USB charger type C, 5 VDC, |A| out: 2050 mA
- 500 mm extendable cable length USB C cable
- 460 x 75 x 57 mm (H x W x D)
- 2000 mm mains connection line, earthing contact plug enclosed loose
- cable outlet behind or below
- suitable for vertical and horizontal mounting

7053203 aluminium black/glass black

219.33 €

Expected to be available from November 2024.



Evoline® BackFlip

When closed, Evoline® BackFlip is just a thin plate on the work surface. At the touch of a finger it turns by 180 degrees and shows its useful side: USB charger and socket are high enough above the plate that they are protected from water.

The installation depth is nevertheless only 53 mm, so it can also be mounted above drawers or devices.

Equipped with new surfaces, Evoline® BackFlip is available in glas black, lacquered black and stainless steel.

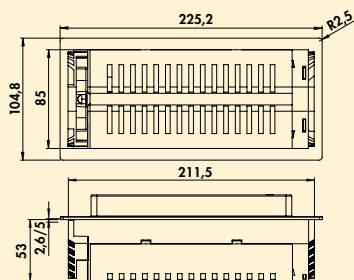

Evoline® BackFlip USB C



Socket element. 2-fold. Rotating with USB C charger (base station).

- installation depth 53 mm
- cut-out dimensions ca. 215 x 88 mm
- 1 x USB charger type C, 5 VDC, IA/I out: 2100 mA
- 2500 mm mains connection line, earthing contact plug enclosed loosely
- flush-mountable
- cable outlet back left

8031186	with earthed plug sockets, flush-mount H 2,6 mm, stainless steel	184.37 €
8031187	with earthed plug sockets, flush-mount H 2,6 mm, painted black	285.04 €
8031188	with earthed plug sockets, flush-mount H 5 mm, glass black	369.66 €
8031279	with earthed plug sockets, flush-mount H 5 mm, glass black matt	369.66 €
NEW!		
8031271	with Belgian/French sockets, flush-mount H 2,6 mm, stainless steel	214.45 €
NEW!		
8031270	with Belgian/French sockets, flush-mount H 2,6 mm, stainless steel	283.87 €
NEW!		
8031272	with Belgian/French sockets, flush-mount H 5 mm, glass black	418.49 €
NEW!		
8031273	with Swiss sockets, flush-mount H 2,6 mm, stainless steel	216.81 €
NEW!		
8031274	with Swiss sockets, flush-mount H 2,6 mm, painted black	314.45 €
NEW!		
8031275	with Swiss sockets, flush-mount H 5 mm, glass black	415.13 €



Evoline® One DisQ

NEW!

Charging system for USB C and inductive charging. The One DisQ is ideal for charging wired and inductive smartphones. The One's USB C modules remain free during the charging process and can be used for other applications at the same time.

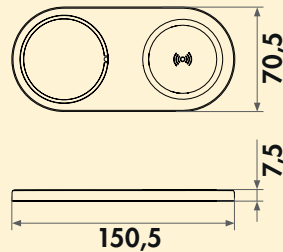

Evoline® One DisQ Qi



Charging station. When closed, the element is almost flush with the worktop. The socket is exposed by turning the lid.

- with support surface for Qi inductive charging (wireless charger). Wireless charging of mobile phones using the Qi standard with a maximum of 15 watts and magnetic holding function
- external plug-in power supply for Qi charging function enclosed loose, for which an additional socket is required
- drill Ø 54 mm
- installation depth 50 mm
- rotating lid black
- 2500 mm mains connection line, two-pin earthed plug enclosed loose
- for worktop thicknesses from 9 mm
- cable outlet rear side

8031280 with earthed plug sockets, black matt

261.85 €

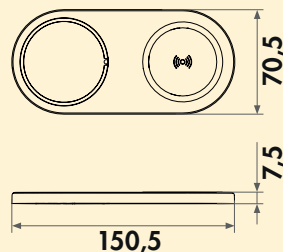

Evoline® One DisQ USB A+C Qi



Charger (base station). With USB A and C charging sockets. When closed, the element is almost flush with the worktop. The USB charging sockets are exposed by turning the lid.

- with support surface for Qi inductive charging (wireless charger). Wireless charging of mobile phones using the Qi standard with a maximum of 15 watts and magnetic holding function
- external plug-in power supply for Qi charging function enclosed loose, for which an additional socket is required
- drill Ø 54 mm
- installation depth 50 mm
- rotating lid black
- USB charger type A+C, 5 V, 2.1 A
- 2500 mm mains connection line, two-pin earthed plug enclosed loose
- for worktop thicknesses from 9 mm
- cable outlet rear side

8031281 black matt

329.58 €



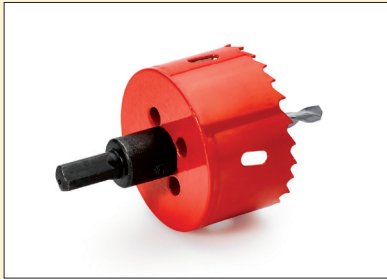

Hole saw



- material HSS for wood/plastic
- cutting depth up to 38 mm
- with reception tool incl. centre drill

7053159 Ø 54 mm, for One

41.72 €

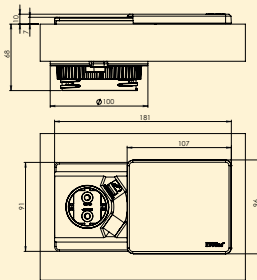

Evoline® Square USB C



Socket element. 1-fold. With USB charger (charging station). When closed, the element is almost flush with the worktop. The socket is exposed by sliding the cover.

- installation depth 68 mm
- sliding cover coated in stainless steel colour
- 1 X USB charger type C, 5 VDC, 1A I out: 2100 mA
- 2500 mm mains connection line, earthing contact plug enclosed loose
- drill Ø ca. 80 mm
- cable outlet below

8031277 with earthed plug socket

103.36 €

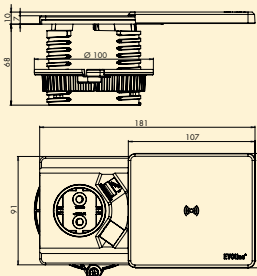

Evoline® Square USB C Qi



Socket element. 1-fold. With USB charger (charging station). When closed, the element is almost flush with the worktop. The socket is exposed by sliding the cover.

- Qi inductive charging station in the cover (wireless charger). Wireless charging of the mobile phones using the Qi standard.
- installation depth 68 mm
- sliding cover coated in stainless steel colour
- 1 X USB charger type C, 5 VDC, 1A I out: 2100 mA
- 2500 mm mains connection line, earthing contact plug enclosed loose
- drill Ø ca. 80 mm
- cable outlet below

8031276 with earthed plug socket

285.71 €



VersaHit Dual (Plaza)

The double socket element VersaHit Dual offers a variety of connection options in a flush-designed housing. The sliding double covers reveal the sockets with slight pressure. For universal installation in worktop, front panel or side wall. The sockets are splash-proof in accordance with IP54.

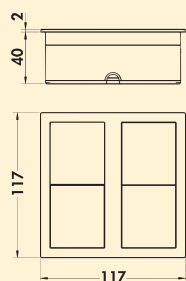

VersaHit Dual USB A/C (Plaza)

NEW! CE

Socket element. 1-fold. With double USB charger (charging station). Built-in socket with double USB charger.

- 3400 watts/16 A, 220–250 VAC, IP54
- 117 x 117 x 40/50 mm (H x W x D)
- cut-out dimensions approx. 108 x 108 mm, R 4 mm
- 2000 mm mains connection line, earthing contact plug supplied loosely
- double USB charger type A+C, 5 V, 2,4 A
- very low installation depth (ca. 40 mm)
- increased contact protection

7053251 brushed stainless steel	205.04 €
7053252 black matt	205.04 €



Pullboy Soft Comfort Laundry laundry container pull-outs

The Pullboy Soft Comfort Laundry is the clean solution for dirty washing. Because with our laundry system, dirty washing can be neatly sorted, stored and transported. Completely invisibly. The concealed chute fits perfectly into any housekeeping area. The new laundry containers in a unique variety of versions are equipped with rounded openings to ensure optimal air circulation and thus protect the laundry.

- pull-out lock with self-closing mechanism and damper
- body thicknesses (16/19 mm)
- available for 60 cm base cabinets

Expected to be available from January 2025.

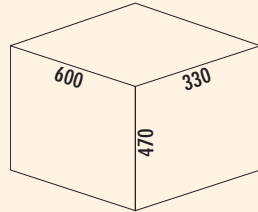

Pullboy Soft Comfort Laundry 470 K/600-2

- Laundry container pull-out.
- frame white/guide silver
 - full pull-out technology
 - mounting cabinet side and front panel
 - container volume 52 (2 x 26) litres
 - with soft retraction and damping
 - installation depth 330 mm

8011728 white

302.52 €

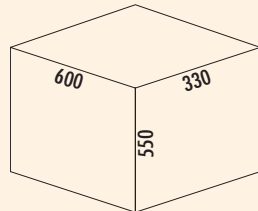
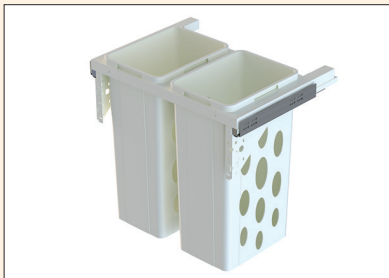
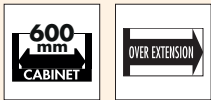

Pullboy Soft Comfort Laundry 550 K/600-2

- Laundry container pull-out.
- frame white/guide silver
 - full pull-out technology
 - mounting cabinet side and front panel
 - container volume 64 (2 x 32) litres
 - with soft retraction and damping
 - installation depth 330 mm

8011729 white

308.40 €

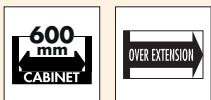

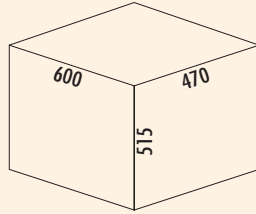
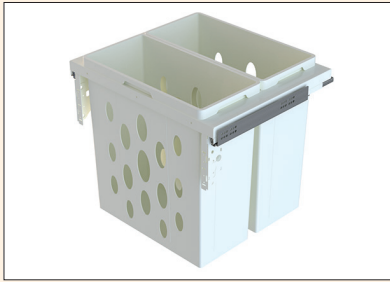

Pullboy Soft Comfort Laundry 515 S/600-2

- Laundry container pull-out.
- frame white/guide silver
 - full pull-out technology
 - mounting cabinet side and front panel
 - container volume 84 (2 x 42) litres
 - with soft retraction and damping
 - installation depth 470 mm

8011726 white

325.21 €

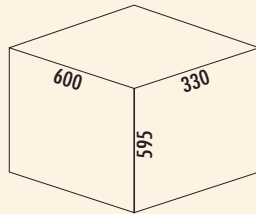

Pullboy Soft Comfort Laundry 595 K/600-1

- Laundry container pull-out.
- frame white/guide silver
 - full pull-out technology
 - mounting cabinet side and front panel
 - container volume 50 (1 x 50) litres
 - with soft retraction and damping
 - installation depth 330 mm

8011727 white

275.63 €



TopSwing

NEW!

Child-proof ease of use: the TopSwing folding table fitting provides a space-saving, flexible tabletop that can easily be lowered with just one hand. The top slides down smoothly from its vertical position on the wall, with the release mechanism positioned high enough that small children can't reach it. When opened, the fitting also acts as a table leg. This guarantees legroom and optimum stability.

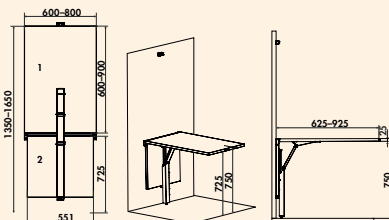
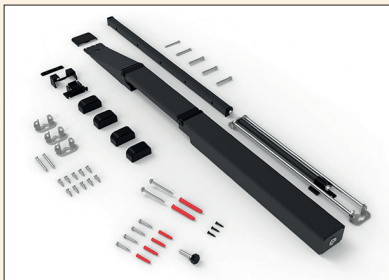

TopSwing

Folding table fitting. **Without tabletops.** For tabletop width 600–800 mm.
 — black matt
 — load capacity max. 30 kg
 — for tabletop thickness 25 mm

3031065 height adapter, matt black **280.50 €**

Optional accessories

3031069 TopSwing height adapter, matt black **14.96 €**



For formats outside of the width-to-height ratio of 1:4, cut-out consultation is required. The scale shown above is not printed on the niche rear wall.

PICit® 132

NEW!

- Niche rear wall.
- aluminium composite or acrylic glass plate
 - UV pressure protection laminate
 - **H max. 700 mm**
 - **L max. 3050 mm**
 - **special sizes available on request**

8061269 aluminium, 3.5 mm, matt, price per m ²	535.29 €
8061270 aluminium, 3.5 mm, glossy, price per m ²	535.29 €
8062269 aluminium, 16 mm, matt, price per m ²	852.94 €
8062270 aluminium, 16 mm, glossy, price per m ²	852.94 €
8063269 acrylic, 3.5 mm, glossy, price per m ²	907.56 €
8064270 acrylic, 16 mm, glossy, price per m ²	1109.24 €
Optional accessories	
8060007 magnetic film, for aluminium, price per m ²	312.61 €

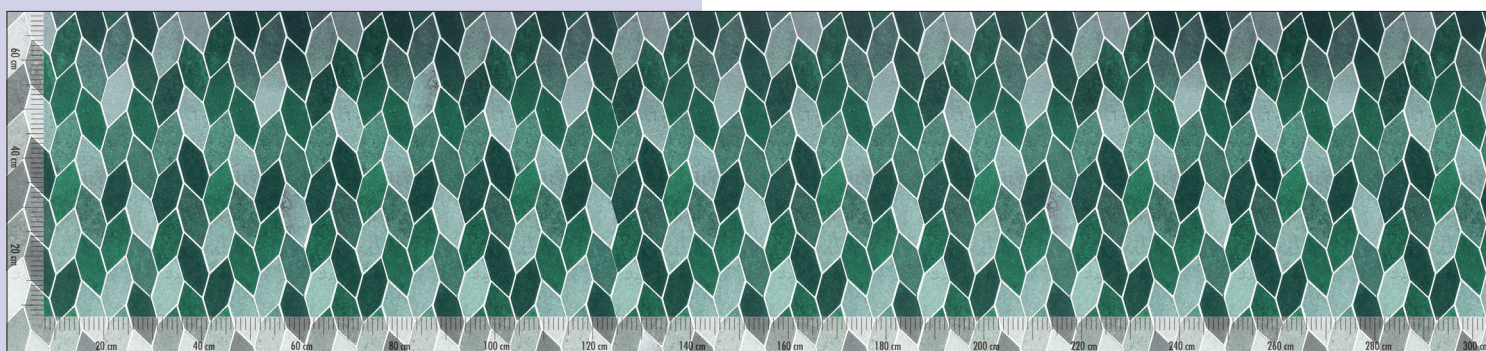

For formats outside of the width-to-height ratio of 1:4, cut-out consultation is required. The scale shown above is not printed on the niche rear wall.

PICit® 133

NEW!

- Niche rear wall.
- aluminium composite or acrylic glass plate
 - UV pressure protection laminate
 - **H max. 700 mm**
 - **L max. 3050 mm**
 - **special sizes available on request**

8061271 aluminium, 3.5 mm, matt, price per m ²	535.29 €
8061272 aluminium, 3.5 mm, glossy, price per m ²	535.29 €
8062271 aluminium, 16 mm, matt, price per m ²	852.94 €
8062272 aluminium, 16 mm, glossy, price per m ²	852.94 €
8063271 acrylic, 3.5 mm, glossy, price per m ²	907.56 €
8064272 acrylic, 16 mm, glossy, price per m ²	1109.24 €
Optional accessories	
8060007 magnetic film, for aluminium, price per m ²	312.61 €



For formats outside of the width-to-height ratio of 1:4, cut-out consultation is required. The scale shown above is not printed on the niche rear wall.

PICi® 134

NEW!

Niche rear wall.

- aluminium composite or acrylic glass plate
- UV pressure protection laminate
- H max. 700 mm
- L max. 3050 mm
- special sizes available on request

8061273	aluminium, 3.5 mm, matt, price per m ²	535.29 €
8061274	aluminium, 3.5 mm, glossy, price per m ²	535.29 €
8062273	aluminium, 16 mm, matt, price per m ²	852.94 €
8062274	aluminium, 16 mm, glossy, price per m ²	852.94 €
8063273	acrylic, 3.5 mm, glossy, price per m ²	907.56 €
8064274	acrylic, 16 mm, glossy, price per m ²	1109.24 €
Optional accessories		
8060007	magnetic film, for aluminium, price per m ²	312.61 €

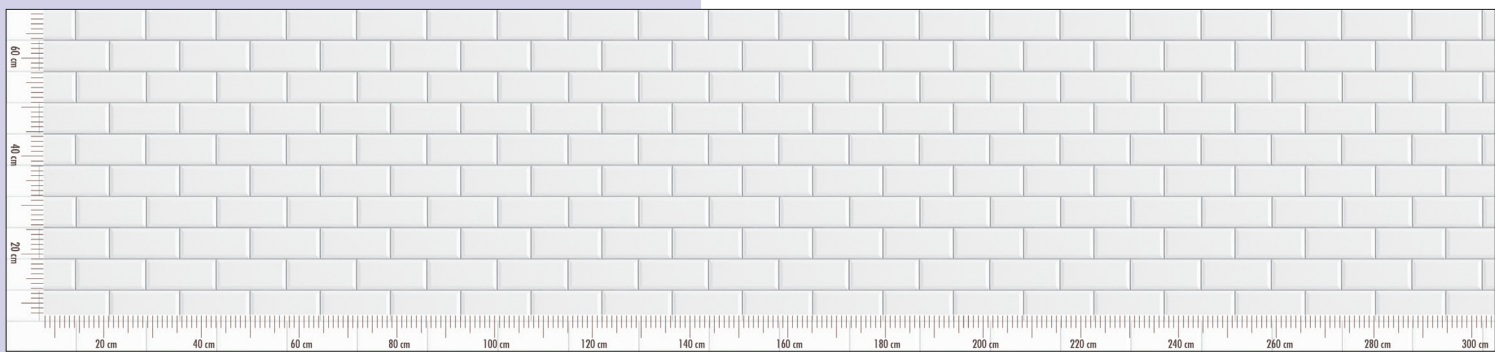

For formats outside of the width-to-height ratio of 1:4, cut-out consultation is required. The scale shown above is not printed on the niche rear wall.

PICi® 135

NEW!

Niche rear wall.

- aluminium composite or acrylic glass plate
- UV pressure protection laminate
- H max. 700 mm
- L max. 3050 mm
- special sizes available on request

8061275	aluminium, 3.5 mm, matt, price per m ²	535.29 €
8061276	aluminium, 3.5 mm, glossy, price per m ²	535.29 €
8062275	aluminium, 16 mm, matt, price per m ²	852.94 €
8062276	aluminium, 16 mm, glossy, price per m ²	852.94 €
8063275	acrylic, 3.5 mm, glossy, price per m ²	907.56 €
8064276	acrylic, 16 mm, glossy, price per m ²	1109.24 €
Optional accessories		
8060007	magnetic film, for aluminium, price per m ²	312.61 €



For formats outside of the width-to-height ratio of 1:4, cut-out consultation is required. The scale shown above is not printed on the niche rear wall.

PICi® 136

NEW!

Niche rear wall.

- aluminium composite or acrylic glass plate
- UV pressure protection laminate
- **H max. 700 mm**
- **L max. 3050 mm**
- **special sizes available on request**

8061277	aluminium, 3.5 mm, matt, price per m ²	535.29 €
8061278	aluminium, 3.5 mm, glossy, price per m ²	535.29 €
8062277	aluminium, 16 mm, matt, price per m ²	852.94 €
8062278	aluminium, 16 mm, glossy, price per m ²	852.94 €
8063277	acrylic, 3.5 mm, glossy, price per m ²	907.56 €
8064278	acrylic, 16 mm, glossy, price per m ²	1109.24 €

Optional accessories

8060007	magnetic film, for aluminium, price per m ²	312.61 €
----------------	--	-----------------



For formats outside of the width-to-height ratio of 1:4, cut-out consultation is required. The scale shown above is not printed on the niche rear wall.

PICi® 137

NEW!

Niche rear wall.

- aluminium composite or acrylic glass plate
- UV pressure protection laminate
- **H max. 700 mm**
- **L max. 3050 mm**
- **special sizes available on request**

8061279	aluminium, 3.5 mm, matt, price per m ²	535.29 €
8061280	aluminium, 3.5 mm, glossy, price per m ²	535.29 €
8062279	aluminium, 16 mm, matt, price per m ²	852.94 €
8062280	aluminium, 16 mm, glossy, price per m ²	852.94 €
8063279	acrylic, 3.5 mm, glossy, price per m ²	907.56 €
8064280	acrylic, 16 mm, glossy, price per m ²	1109.24 €

Optional accessories

8060007	magnetic film, for aluminium, price per m ²	312.61 €
----------------	--	-----------------



For formats outside of the width-to-height ratio of 1:4, cut-out consultation is required. The scale shown above is not printed on the niche rear wall.

PICi® 138

NEW!

Niche rear wall.

- aluminium composite or acrylic glass plate
- UV pressure protection laminate
- **H max. 700 mm**
- **L max. 3050 mm**
- **special sizes available on request**

8061281	aluminium, 3.5 mm, matt, price per m ²	535.29 €
8061282	aluminium, 3.5 mm, glossy, price per m ²	535.29 €
8062281	aluminium, 16 mm, matt, price per m ²	852.94 €
8062282	aluminium, 16 mm, glossy, price per m ²	852.94 €

8063281	acrylic, 3.5 mm, glossy, price per m ²	907.56 €
8064282	acrylic, 16 mm, glossy, price per m ²	1109.24 €

Optional accessories

8060007	magnetic film, for aluminium, price per m ²	312.61 €
----------------	--	-----------------



For formats outside of the width-to-height ratio of 1:4, cut-out consultation is required. The scale shown above is not printed on the niche rear wall.

PICi® 139

NEW!

Niche rear wall.

- aluminium composite or acrylic glass plate
- UV pressure protection laminate
- **H max. 700 mm**
- **L max. 3050 mm**
- **special sizes available on request**

8061283	aluminium, 3.5 mm, matt, price per m ²	535.29 €
8061284	aluminium, 3.5 mm, glossy, price per m ²	535.29 €
8062283	aluminium, 16 mm, matt, price per m ²	852.94 €
8062284	aluminium, 16 mm, glossy, price per m ²	852.94 €

8063283	acrylic, 3.5 mm, glossy, price per m ²	907.56 €
8064284	acrylic, 16 mm, glossy, price per m ²	1109.24 €

Optional accessories

8060007	magnetic film, for aluminium, price per m ²	312.61 €
----------------	--	-----------------



For formats outside of the width-to-height ratio of 1:4, cut-out consultation is required. The scale shown above is not printed on the niche rear wall.

PICi® 140

NEW!

Niche rear wall.

- aluminium composite or acrylic glass plate
- UV pressure protection laminate
- **H max. 700 mm**
- **L max. 3050 mm**
- special sizes available on request

8061285 aluminium, 3.5 mm, matt, price per m² **535.29 €**

8061286 aluminium, 3.5 mm, glossy, price per m² **535.29 €**

8062285 aluminium, 16 mm, matt, price per m² **852.94 €**

8062286 aluminium, 16 mm, glossy, price per m² **852.94 €**

8063285 acrylic, 3.5 mm, glossy, price per m² **907.56 €**

8064286 acrylic, 16 mm, glossy, price per m² **1109.24 €**

Optional accessories

8060007 magnetic film, for aluminium, price per m² **312.61 €**



For formats outside of the width-to-height ratio of 1:4, cut-out consultation is required. The scale shown above is not printed on the niche rear wall.

PICi® 141

NEW!

Niche rear wall.

- aluminium composite or acrylic glass plate
- UV pressure protection laminate
- **H max. 700 mm**
- **L max. 3050 mm**
- special sizes available on request

8061287 aluminium, 3.5 mm, matt, price per m² **535.29 €**

8061288 aluminium, 3.5 mm, glossy, price per m² **535.29 €**

8062287 aluminium, 16 mm, matt, price per m² **852.94 €**

8062288 aluminium, 16 mm, glossy, price per m² **852.94 €**

8063287 acrylic, 3.5 mm, glossy, price per m² **907.56 €**

8064288 acrylic, 16 mm, glossy, price per m² **1109.24 €**

Optional accessories

8060007 magnetic film, for aluminium, price per m² **312.61 €**

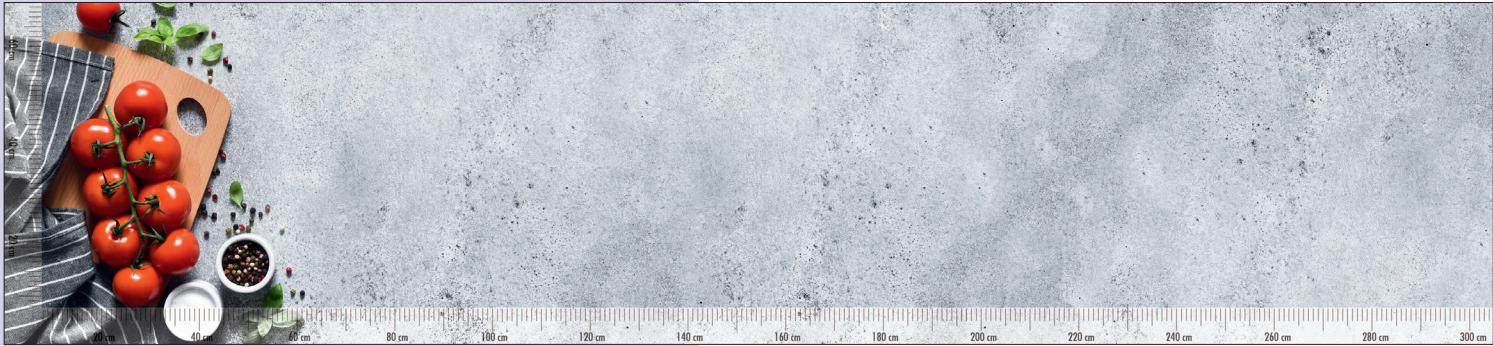

For formats outside of the width-to-height ratio of 1:4, cut-out consultation is required. The scale shown above is not printed on the niche rear wall.

PICi® 142

NEW!

Niche rear wall.

- aluminium composite or acrylic glass plate
- UV pressure protection laminate
- **H max. 700 mm**
- **L max. 3050 mm**
- **special sizes available on request**

8061289 aluminium, 3.5 mm, matt, price per m ²	535.29 €
--	-----------------

8061290 aluminium, 3.5 mm, glossy, price per m ²	535.29 €
--	-----------------

8062289 aluminium, 16 mm, matt, price per m ²	852.94 €
---	-----------------

8062290 aluminium, 16 mm, glossy, price per m ²	852.94 €
---	-----------------

8063289 acrylic, 3.5 mm, glossy, price per m ²	907.56 €
--	-----------------

8064290 acrylic, 16 mm, glossy, price per m ²	1109.24 €
---	------------------

Optional accessories

8060007 magnetic film, for aluminium, price per m ²	312.61 €
---	-----------------



For formats outside of the width-to-height ratio of 1:4, cut-out consultation is required. The scale shown above is not printed on the niche rear wall.

PICi® 143

NEW!

Niche rear wall.

- aluminium composite or acrylic glass plate
- UV pressure protection laminate
- **H max. 700 mm**
- **L max. 3050 mm**
- **special sizes available on request**

8061291 aluminium, 3.5 mm, matt, price per m ²	535.29 €
--	-----------------

8061292 aluminium, 3.5 mm, glossy, price per m ²	535.29 €
--	-----------------

8062291 aluminium, 16 mm, matt, price per m ²	852.94 €
---	-----------------

8062292 aluminium, 16 mm, glossy, price per m ²	852.94 €
---	-----------------

8063291 acrylic, 3.5 mm, glossy, price per m ²	907.56 €
--	-----------------

8064292 acrylic, 16 mm, glossy, price per m ²	1109.24 €
---	------------------

Optional accessories

8060007 magnetic film, for aluminium, price per m ²	312.61 €
---	-----------------

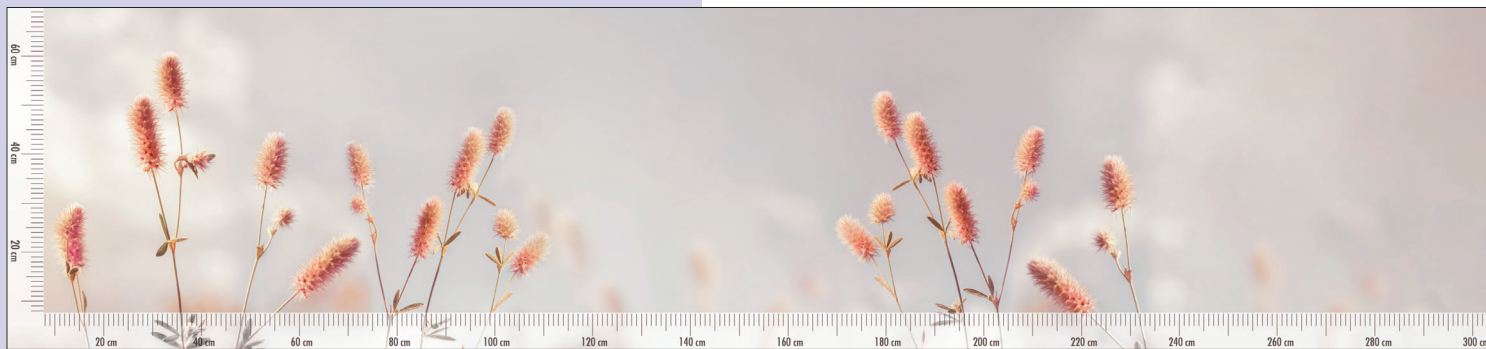

For formats outside of the width-to-height ratio of 1:4, cut-out consultation is required. The scale shown above is not printed on the niche rear wall.

PICit® 144

NEW!

Niche rear wall.

- aluminium composite or acrylic glass plate
- UV pressure protection laminate
- **H max. 700 mm**
- **L max. 3050 mm**
- **special sizes available on request**

8061293 aluminium, 3.5 mm, matt, price per m ²	535.29 €
8061294 aluminium, 3.5 mm, glossy, price per m ²	535.29 €
8062293 aluminium, 16 mm, matt, price per m ²	852.94 €
8062294 aluminium, 16 mm, glossy, price per m ²	852.94 €

8063293 acrylic, 3.5 mm, glossy, price per m ²	907.56 €
8064294 acrylic, 16 mm, glossy, price per m ²	1109.24 €

Optional accessories

8060007 magnetic film, for aluminium, price per m ²	312.61 €
---	-----------------

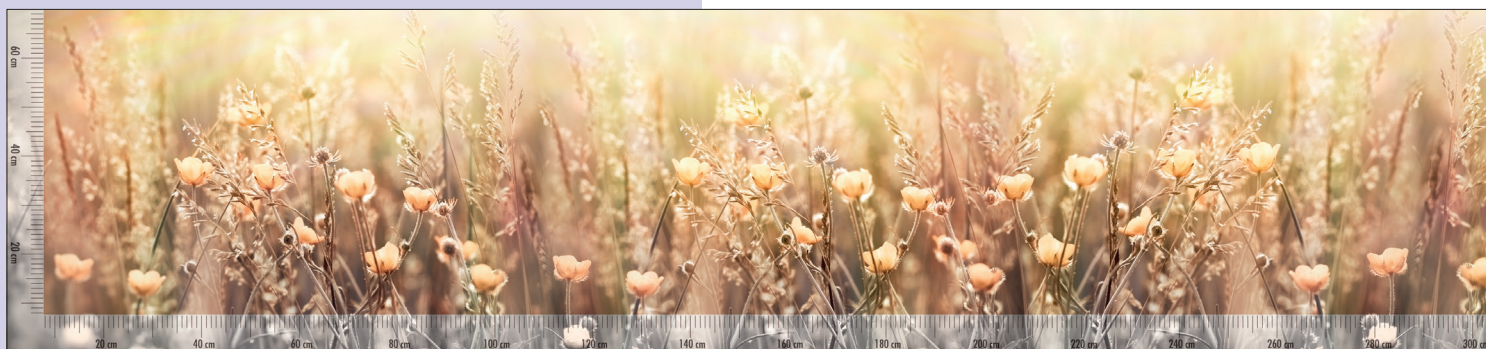

For formats outside of the width-to-height ratio of 1:4, cut-out consultation is required. The scale shown above is not printed on the niche rear wall.

PICit® 145

NEW!

Niche rear wall.

- aluminium composite or acrylic glass plate
- UV pressure protection laminate
- **H max. 700 mm**
- **L max. 3050 mm**
- **special sizes available on request**

8061295 aluminium, 3.5 mm, matt, price per m ²	535.29 €
8061296 aluminium, 3.5 mm, glossy, price per m ²	535.29 €
8062295 aluminium, 16 mm, matt, price per m ²	852.94 €
8062296 aluminium, 16 mm, glossy, price per m ²	852.94 €

8063295 acrylic, 3.5 mm, glossy, price per m ²	907.56 €
8064296 acrylic, 16 mm, glossy, price per m ²	1109.24 €

Optional accessories

8060007 magnetic film, for aluminium, price per m ²	312.61 €
---	-----------------



For formats outside of the width-to-height ratio of 1:4, cut-out consultation is required. The scale shown above is not printed on the niche rear wall.

PICi® 146

NEW!

Niche rear wall.

- aluminium composite or acrylic glass plate
- UV pressure protection laminate
- **H max. 700 mm**
- **L max. 3050 mm**
- **special sizes available on request**

8061297	aluminium, 3.5 mm, matt, price per m ²	535.29 €
8061298	aluminium, 3.5 mm, glossy, price per m ²	535.29 €
8062297	aluminium, 16 mm, matt, price per m ²	852.94 €
8062298	aluminium, 16 mm, glossy, price per m ²	852.94 €

8063297	acrylic, 3.5 mm, glossy, price per m ²	907.56 €
8064298	acrylic, 16 mm, glossy, price per m ²	1109.24 €

Optional accessories

8060007	magnetic film, for aluminium, price per m ²	312.61 €
----------------	--	-----------------

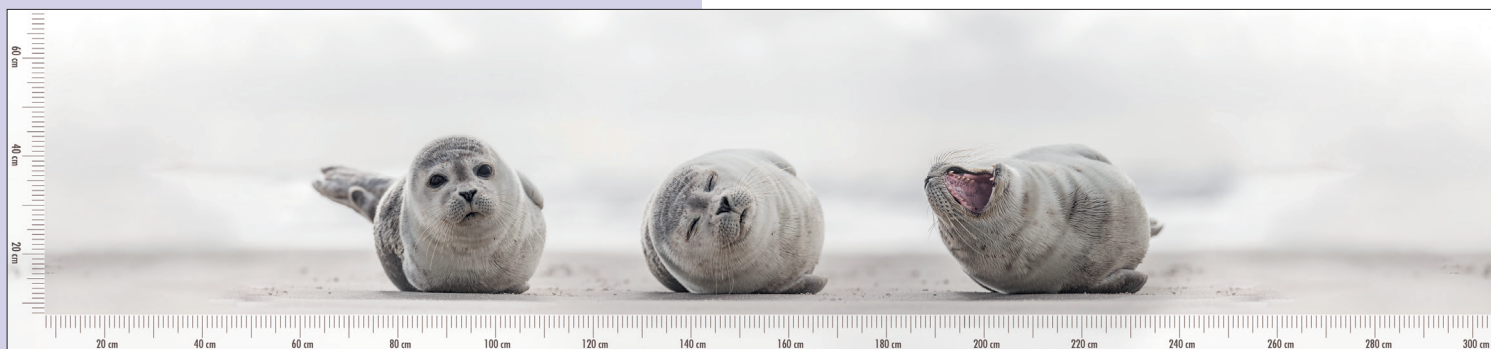

For formats outside of the width-to-height ratio of 1:4, cut-out consultation is required. The scale shown above is not printed on the niche rear wall.

PICi® 147

NEW!

Niche rear wall.

- aluminium composite or acrylic glass plate
- UV pressure protection laminate
- **H max. 700 mm**
- **L max. 3050 mm**
- **special sizes available on request**

8061299	aluminium, 3.5 mm, matt, price per m ²	535.29 €
8061300	aluminium, 3.5 mm, glossy, price per m ²	535.29 €
8062299	aluminium, 16 mm, matt, price per m ²	852.94 €
8062300	aluminium, 16 mm, glossy, price per m ²	852.94 €

8063299	acrylic, 3.5 mm, glossy, price per m ²	907.56 €
8064300	acrylic, 16 mm, glossy, price per m ²	1109.24 €

Optional accessories

8060007	magnetic film, for aluminium, price per m ²	312.61 €
----------------	--	-----------------

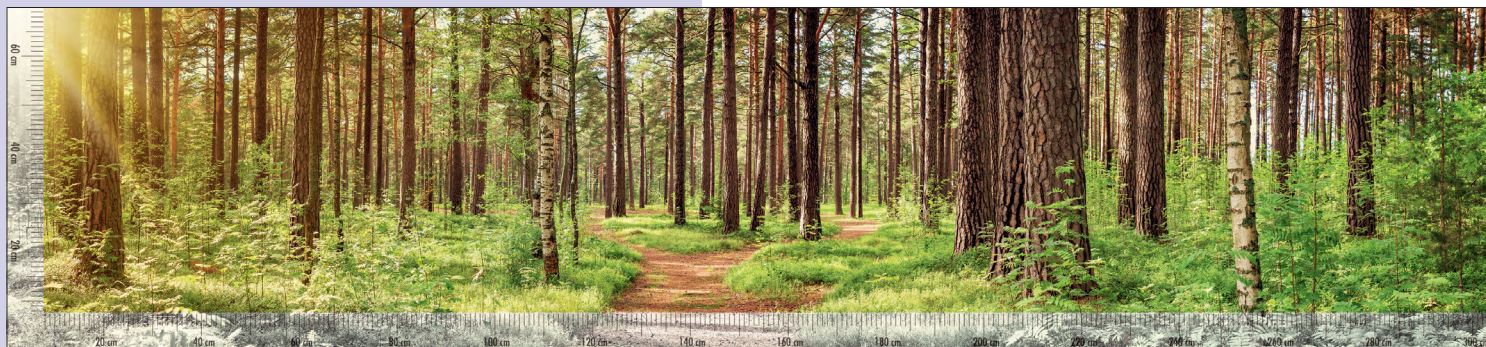

For formats outside of the width-to-height ratio of 1:4, cut-out consultation is required. The scale shown above is not printed on the niche rear wall.

PICi® 148

NEW!

Niche rear wall.

- aluminium composite or acrylic glass plate
- UV pressure protection laminate
- **H max. 700 mm**
- **L max. 3050 mm**
- **special sizes available on request**

8061301 aluminium, 3.5 mm, matt, price per m ²	535.29 €
8061302 aluminium, 3.5 mm, glossy, price per m ²	535.29 €
8062301 aluminium, 16 mm, matt, price per m ²	852.94 €
8062302 aluminium, 16 mm, glossy, price per m ²	852.94 €

8063301 acrylic, 3.5 mm, glossy, price per m ²	907.56 €
8064302 acrylic, 16 mm, glossy, price per m ²	1109.24 €

Optional accessories

8060007 magnetic film, for aluminium, price per m ²	312.61 €
---	-----------------

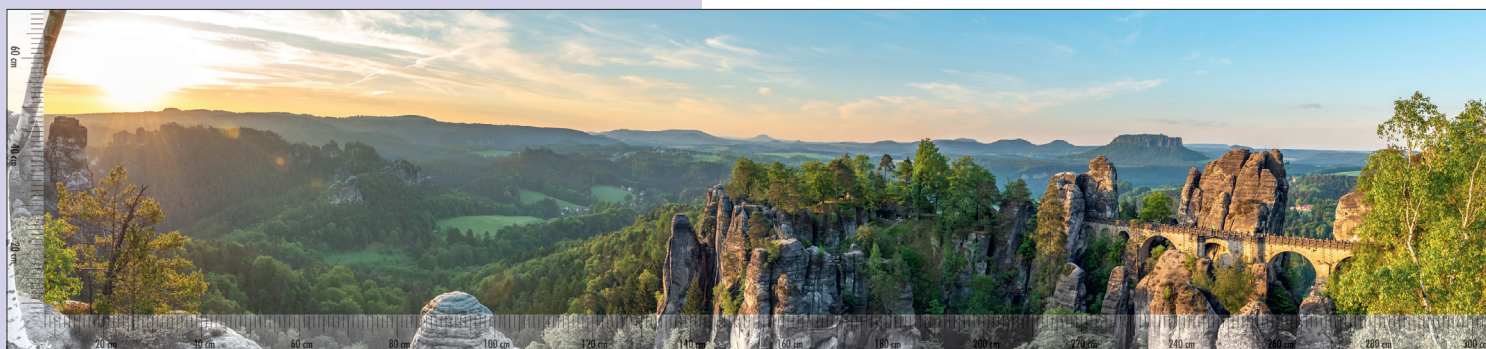

For formats outside of the width-to-height ratio of 1:4, cut-out consultation is required. The scale shown above is not printed on the niche rear wall.

PICi® 149

NEW!

Niche rear wall.

- aluminium composite or acrylic glass plate
- UV pressure protection laminate
- **H max. 700 mm**
- **L max. 3050 mm**
- **special sizes available on request**

8061303 aluminium, 3.5 mm, matt, price per m ²	535.29 €
8061304 aluminium, 3.5 mm, glossy, price per m ²	535.29 €
8062303 aluminium, 16 mm, matt, price per m ²	852.94 €
8062304 aluminium, 16 mm, glossy, price per m ²	852.94 €

8063303 acrylic, 3.5 mm, glossy, price per m ²	907.56 €
8064304 acrylic, 16 mm, glossy, price per m ²	1109.24 €

Optional accessories

8060007 magnetic film, for aluminium, price per m ²	312.61 €
---	-----------------



For formats outside of the width-to-height ratio of 1:4, cut-out consultation is required. The scale shown above is not printed on the niche rear wall.

PICi® 150

NEW!

- <div>Niche rear wall.
- aluminium composite or acrylic glass plate
- UV pressure protection laminate
- **H max. 700 mm**
- **L max. 3050 mm**
- **special sizes available on request</div>**

8061305 aluminium, 3.5 mm, matt, price per m ²	535.29 €
8061306 aluminium, 3.5 mm, glossy, price per m ²	535.29 €
8062305 aluminium, 16 mm, matt, price per m ²	852.94 €
8062306 aluminium, 16 mm, glossy, price per m ²	852.94 €
8063305 acrylic, 3.5 mm, glossy, price per m ²	907.56 €
8064306 acrylic, 16 mm, glossy, price per m ²	1109.24 €
Optional accessories	
8060007 magnetic film, for aluminium, price per m ²	312.61 €

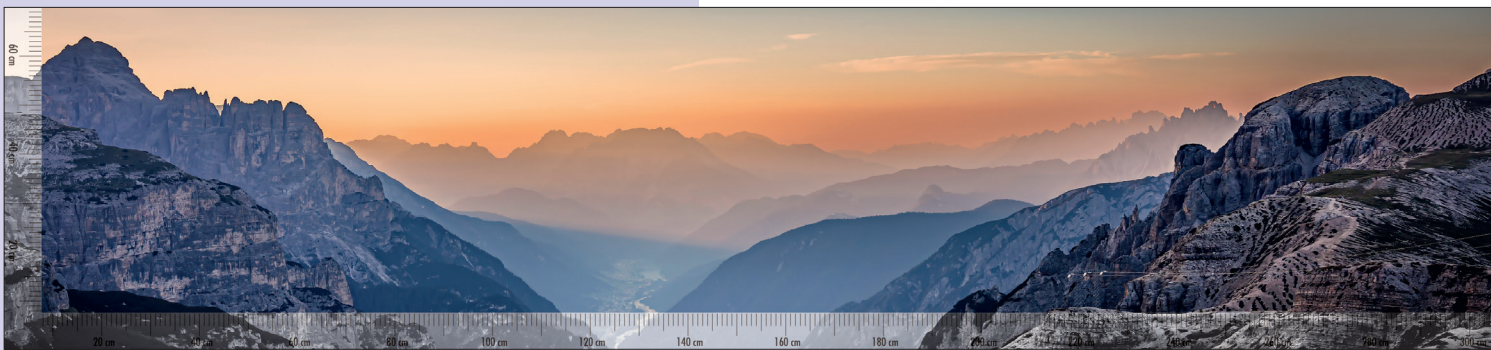

For formats outside of the width-to-height ratio of 1:4, cut-out consultation is required. The scale shown above is not printed on the niche rear wall.

PICi® 151

NEW!

- <div>Niche rear wall.
- aluminium composite or acrylic glass plate
- UV pressure protection laminate
- **H max. 700 mm**
- **L max. 3050 mm**
- **special sizes available on request</div>**

8061307 aluminium, 3.5 mm, matt, price per m ²	535.29 €
8061308 aluminium, 3.5 mm, glossy, price per m ²	535.29 €
8062307 aluminium, 16 mm, matt, price per m ²	852.94 €
8062308 aluminium, 16 mm, glossy, price per m ²	852.94 €
8063307 acrylic, 3.5 mm, glossy, price per m ²	907.56 €
8064308 acrylic, 16 mm, glossy, price per m ²	1109.24 €
Optional accessories	
8060007 magnetic film, for aluminium, price per m ²	312.61 €

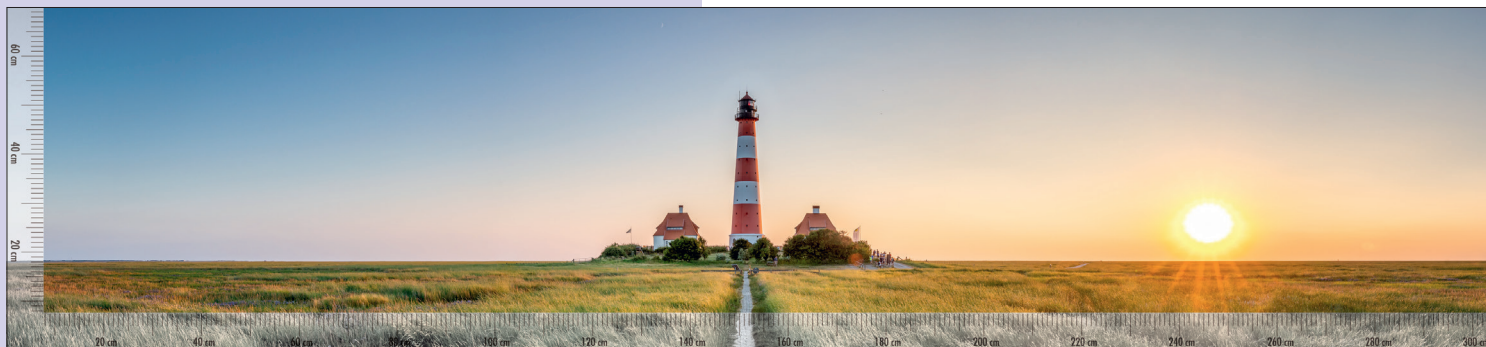

For formats outside of the width-to-height ratio of 1:4, cut-out consultation is required. The scale shown above is not printed on the niche rear wall.

PICi® 152

NEW!

Niche rear wall.

- aluminium composite or acrylic glass plate
- UV pressure protection laminate
- **H max. 700 mm**
- **L max. 3050 mm**
- **special sizes available on request**

8061309 aluminium, 3.5 mm, matt, price per m ²	535.29 €
8061310 aluminium, 3.5 mm, glossy, price per m ²	535.29 €
8062309 aluminium, 16 mm, matt, price per m ²	852.94 €
8062310 aluminium, 16 mm, glossy, price per m ²	852.94 €

8063309 acrylic, 3.5 mm, glossy, price per m ²	907.56 €
8064310 acrylic, 16 mm, glossy, price per m ²	1109.24 €

Optional accessories

8060007 magnetic film, for aluminium, price per m ²	312.61 €
---	-----------------

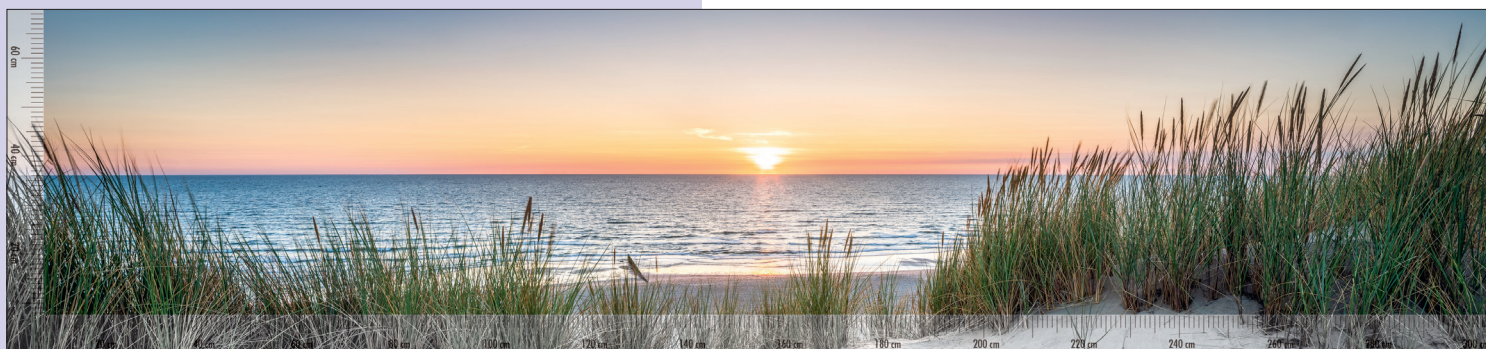

For formats outside of the width-to-height ratio of 1:4, cut-out consultation is required. The scale shown above is not printed on the niche rear wall.

PICi® 153

NEW!

Niche rear wall.

- aluminium composite or acrylic glass plate
- UV pressure protection laminate
- **H max. 700 mm**
- **L max. 3050 mm**
- **special sizes available on request**

8061311 aluminium, 3.5 mm, matt, price per m ²	535.29 €
8061312 aluminium, 3.5 mm, glossy, price per m ²	535.29 €
8062311 aluminium, 16 mm, matt, price per m ²	852.94 €
8062312 aluminium, 16 mm, glossy, price per m ²	852.94 €

8063311 acrylic, 3.5 mm, glossy, price per m ²	907.56 €
8064312 acrylic, 16 mm, glossy, price per m ²	1109.24 €

Optional accessories

8060007 magnetic film, for aluminium, price per m ²	312.61 €
---	-----------------



For formats outside of the width-to-height ratio of 1:4, cut-out consultation is required. The scale shown above is not printed on the niche rear wall.

PICi® 154

NEW!

- Niche rear wall.
- aluminium composite or acrylic glass plate
 - UV pressure protection laminate
 - **H max. 700 mm**
 - **L max. 3050 mm**
 - **special sizes available on request**

8061313	aluminium, 3.5 mm, matt, price per m ²	535.29 €
8061314	aluminium, 3.5 mm, glossy, price per m ²	535.29 €
8062313	aluminium, 16 mm, matt, price per m ²	852.94 €
8062314	aluminium, 16 mm, glossy, price per m ²	852.94 €
8063313	acrylic, 3.5 mm, glossy, price per m ²	907.56 €
8064314	acrylic, 16 mm, glossy, price per m ²	1109.24 €
Optional accessories		
8060007	magnetic film, for aluminium, price per m ²	312.61 €

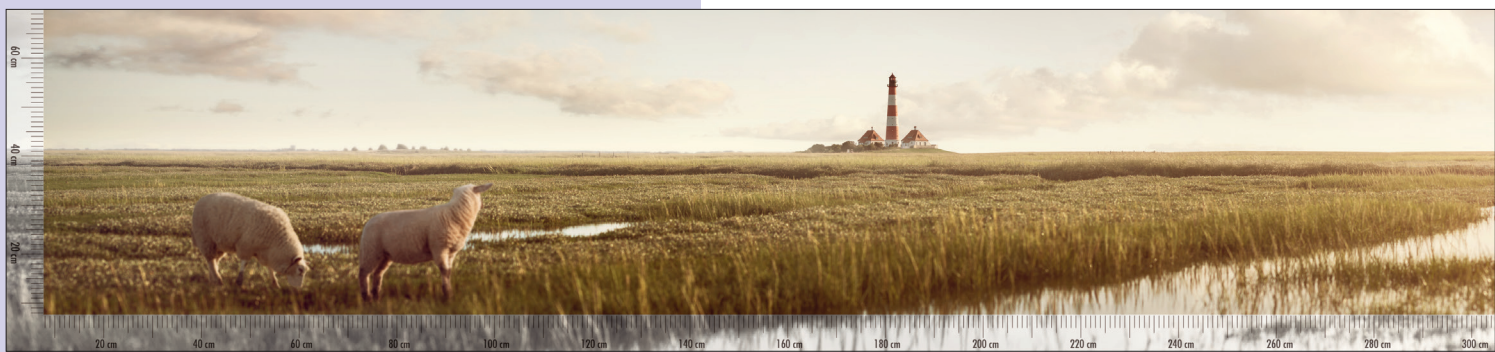

For formats outside of the width-to-height ratio of 1:4, cut-out consultation is required. The scale shown above is not printed on the niche rear wall.

PICi® 155

NEW!

- Niche rear wall.
- aluminium composite or acrylic glass plate
 - UV pressure protection laminate
 - **H max. 700 mm**
 - **L max. 3050 mm**
 - **special sizes available on request**

8061315	aluminium, 3.5 mm, matt, price per m ²	535.29 €
8061316	aluminium, 3.5 mm, glossy, price per m ²	535.29 €
8062315	aluminium, 16 mm, matt, price per m ²	852.94 €
8062316	aluminium, 16 mm, glossy, price per m ²	852.94 €
8063315	acrylic, 3.5 mm, glossy, price per m ²	907.56 €
8064316	acrylic, 16 mm, glossy, price per m ²	1109.24 €
Optional accessories		
8060007	magnetic film, for aluminium, price per m ²	312.61 €



For formats outside of the width-to-height ratio of 1:4, cut-out consultation is required. The scale shown above is not printed on the niche rear wall.

PICit® 156

NEW!

Niche rear wall.

- aluminium composite or acrylic glass plate
- UV pressure protection laminate
- H max. 700 mm
- L max. 3050 mm
- special sizes available on request

8061317	aluminium, 3.5 mm, matt, price per m ²	535.29 €
8061318	aluminium, 3.5 mm, glossy, price per m ²	535.29 €
8062317	aluminium, 16 mm, matt, price per m ²	852.94 €
8062318	aluminium, 16 mm, glossy, price per m ²	852.94 €

8063317	acrylic, 3.5 mm, glossy, price per m ²	907.56 €
8064318	acrylic, 16 mm, glossy, price per m ²	1109.24 €

Optional accessories

8060007	magnetic film, for aluminium, price per m ²	312.61 €
---------	--	----------



For formats outside of the width-to-height ratio of 1:4, cut-out consultation is required. The scale shown above is not printed on the niche rear wall.

PICit® 157

NEW!

<div class="flags gb"> </div>

<div>Niche rear wall.

- aluminium composite or acrylic glass plate
- UV pressure protection laminate
- H max. 700 mm
- L max. 3050 mm
- special sizes available on request</div>

8061319	aluminium, 3.5 mm, matt, price per m ²	535.29 €
8061320	aluminium, 3.5 mm, glossy, price per m ²	535.29 €
8062319	aluminium, 16 mm, matt, price per m ²	852.94 €
8062320	aluminium, 16 mm, glossy, price per m ²	852.94 €

8063319	acrylic, 3.5 mm, glossy, price per m ²	907.56 €
8064320	acrylic, 16 mm, glossy, price per m ²	1109.24 €

Optional accessories

8060007	magnetic film, for aluminium, price per m ²	312.61 €
---------	--	----------

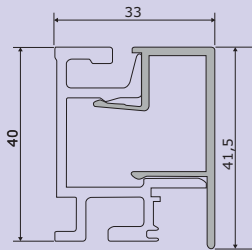
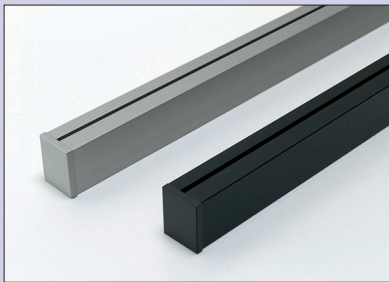

Linero Style profile strips set

Rail system. Aluminium.

Set consisting of:

- 1 aluminium profile strip (42.5 x 33 mm, H x D)
- 2 end pieces, 1 connector plus screws and dowels

8047430	L 600 mm, stainless steel coloured	71.85 €
8047432	L 900 mm, stainless steel coloured	99.75 €
8047434	L 1200 mm, stainless steel coloured	134.12 €
8047436	L 1500 mm, stainless steel coloured	165.38 €
8047431	L 600 mm, black matt	81.34 €
8047433	L 900 mm, black matt	113.03 €
8047435	L 1200 mm, black matt	151.86 €
8047437	L 1500 mm, black matt	187.39 €



Linero Style spice rack

Two levels, for bottles and pots up to Ø 66 mm and ca. 110 mm height.

- 275 x 380 x 80 mm (H x W x D)

8047438	stainless steel coloured	137.73 €
8047439	black matt	125.29 €

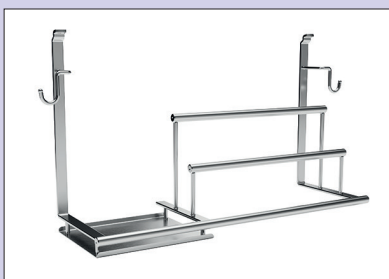

Linero Style holder for dishwashing paraphernalia

- 275 x 501 x 150 mm (H x W x D)

8047440	stainless steel coloured	139.50 €
8047441	black matt	129.50 €

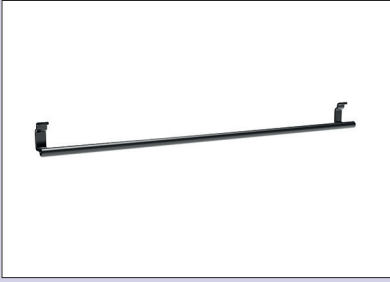

Linero Style cloth strip

Can be hooked in from above.
— 45 x 571 x 38 mm (H x W x D)

8047442	stainless steel coloured	39.92 €
8047443	black matt	36.30 €

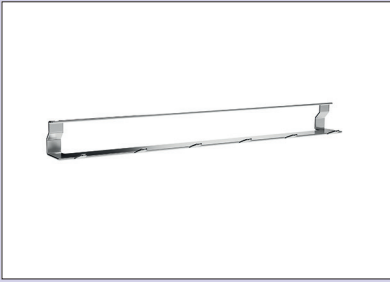

Linero Style hook strip 1

6-fold.
— 37.4 x 380 x 51 mm (H x W x D)

8047444	stainless steel coloured	44.87 €
8047445	black matt	39.92 €



Linero Style paper roll holder

For household rolls. 1-fold. Hooked in from below.
— 255 x 352 x 150 mm (H x W x D)

8047446	stainless steel coloured	65.29 €
8047447	black matt	59.08 €



Linero Style universal tray

— 275 x 440 x 150 mm (H x W x D)

8047448	stainless steel coloured	110.76 €
8047449	black matt	99.66 €



Linero Style roll holder

3 levels. With tear-off attachment for aluminium foil and cling film. Suitable for foils up to a width of 325 mm.
— 305 x 352 x 150 mm (H x W x D)

8047450	stainless steel coloured	217.82 €
8047451	black matt	198.99 €



Linero Style knife holder

The knife block itself is made of plastic and holds 5 knives. It is attached to the metal frame by magnets which hold the knife block firmly in place. The knives can be removed from the left or the right.
— 256 x 352 x 150 mm (H x W x D)

8047112	stainless steel coloured/black matt	126.05 €
8047452	black matt	123.62 €



Linero Style hook strip 2

2-fold.

— 37.4 x 84 x 51 mm (H x W x D)

8047453 stainless steel coloured	47.39 €
8047454 black matt	43.11 €

VIVACE

Waste containers

Harmony of technology
and design



■ Cosmetic bin 113	Page 72
Pedal bin 116	Page 72
Capboy Maxi	Page 72
Gastro pedal bin 127	Page 73
Baseboy 20	Page 73
Big Baseboy 30	Page 73
Eco bin 170	Page 74
Pushboy Junior	Page 74
Pushboy	Page 75
Kickboy	Page 75
Mini Master	Page 76
Kickmaster Junior	Page 76
Kickmaster Maxi	Page 76
Kickmaster	Page 77
Big Double Boy	Page 77
Big Swing	Page 78
Dassa	Page 78



VIVACE

Waste containers



Always positioned precisely where waste accumulates. Yet by no means a foreign body, they are an attractive part of the home or business ambience: the **VIVACE waste collectors**.

The shapes are varied and ingenious. Round shapes are central features in the room, create a harmonious effect and balance out edges and corners. Rectangular collectors fit snugly against walls and corners, making optimum use of the space available. All the shapes have more volume than the dimensions of the base suggest.

The sizes are as varied as the rooms and needs of the users. From the **cosmetics bin** with the smallest volume and the **Mini Master** for children's rooms or bathrooms to the double waste collector **Eco-collector** or the gigantic **Big Swing** for big quantities of waste - there is a wide choice of sizes and shapes.

The special charm: almost all models are available in a wide range of colours, from subtly understated to cheerful and lively.

The material is high-quality coated sheet steel. Anti-slip base structures provide stability, and built-in dampers mean that the lids close almost without a sound. Depending on the use, the inserts are made of plastic or metal. A sturdy foot pedal makes for easy operation and a firm grip when opening.

Clear design, reliable functionality, generous waste openings, odour-free sealing of the contents: quite simply the way waste collectors should be!

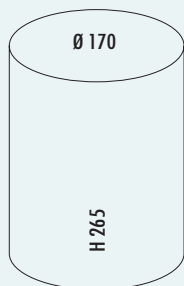

Cosmetic bin 113

NEW!

- waste capacity 3 litres
- powder-coated sheet steel body
- plastic insert
- metal/plastic foot pedal
- plastic base ring

8036140	black matt	24.37 €
8036141	white matt	24.37 €
8036142	graphite matt	24.37 €
8036143	sand matt	24.37 €

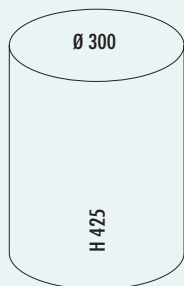

Pedal bin 116

NEW!

- waste capacity 13 litres
- powder-coated sheet steel body and lid
- plastic insert
- plastic foot pedal
- plastic base ring

8012148	white	75.80 €
8012165	red	75.80 €
8012150	nickel silver	75.80 €
8012151	graphite	75.80 €
8012152	almond	75.80 €
8036161	black	75.80 €
8012166	black matt	75.80 €
8012167	white matt	75.80 €
8012168	graphite matt	75.80 €
8012169	sand matt	75.80 €

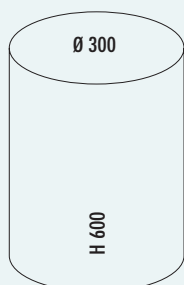

Capboy Maxi

NEW!

- waste capacity 22 litres
- powder-coated sheet steel body and lid
- metal insert
- plastic foot pedal
- plastic base ring

8012170	white	104.20 €
8012171	red	104.20 €
8012172	nickel silver	104.20 €
8012173	graphite	104.20 €
8012174	almond	104.20 €
8012358	pink	104.20 €
8012359	mint	104.20 €
8012175	black matt	104.20 €
8012176	white matt	104.20 €
8012177	graphite matt	104.20 €
8012178	sand matt	104.20 €

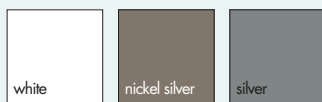
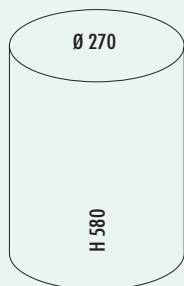

Gastro pedal bin 127

NEW!

- waste capacity 22 litres
- powder-coated sheet steel body
- metal insert
- plastic foot pedal

8012179	white	98.32 €
8012180	nickel silver	98.32 €
8012181	silver	98.32 €

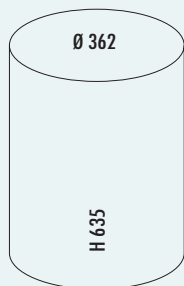

Baseboy 20

NEW!

- waste capacity 20 litres
- powder-coated sheet steel body and lid
- metal insert
- metal foot pedal with rubber tread surface
- plastic base ring

8011511	red	178.99 €
8011680	nickel silver	178.99 €
8011512	graphite	178.99 €
8011513	almond	178.99 €
8011514	black	178.99 €
8011515	black matt	178.99 €
8011516	white matt	178.99 €
8011517	graphite matt	178.99 €
8011518	sand matt	178.99 €

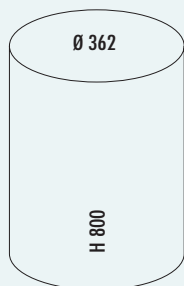

Big Baseboy 30

NEW!

- waste capacity 30 litres
- powder-coated sheet steel body and lid
- metal insert
- metal foot pedal with rubber tread surface
- plastic base ring

8011519	white	198.32 €
8011520	red	198.32 €
8011521	nickel silver	198.32 €
8011522	graphite	198.32 €
8011523	almond	198.32 €
8011524	black	198.32 €
8011525	black matt	198.32 €
8011526	white matt	198.32 €
8011527	graphite matt	198.32 €
8011528	sand matt	198.32 €

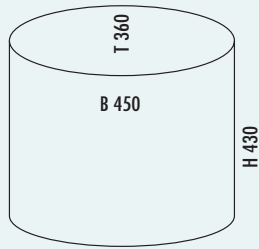

Eco bin 170

NEW!

Double waste collector with two inserts.

- depth 360 mm
- waste capacity 30 (2 x 15) litres
- powder-coated sheet steel body
- plastic lid
- plastic insert
- plastic foot pedal
- plastic base ring

8011532	white	88.24 €
8011533	red	88.24 €
8011080	silver	88.24 €
8011534	almond	88.24 €
8011535	black	88.24 €
8011580	mint	88.24 €
8011595	warm grey	88.24 €
8011609	cool grey	88.24 €

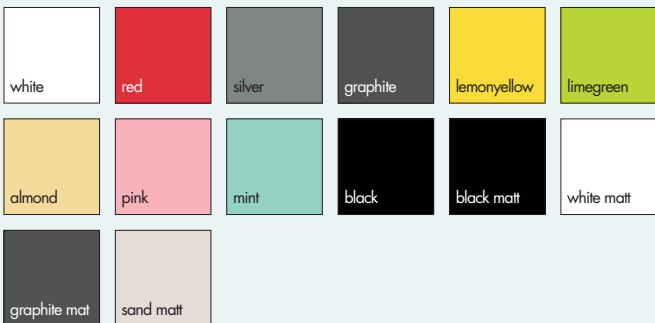
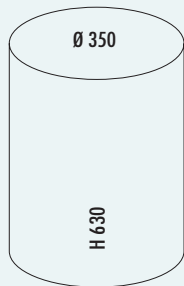
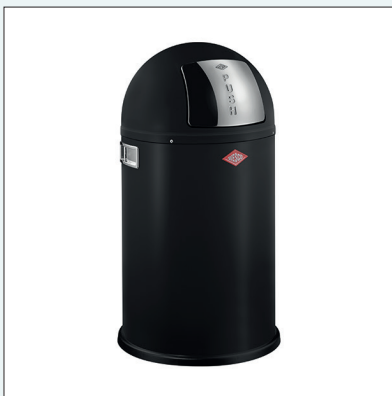

Pushboy Junior

NEW!

- waste capacity 22 litres
- powder-coated sheet steel body
- stainless-steel flap
- chrome-plated plastic handles
- metal insert
- plastic base ring

8011536	white	142.02 €
8011537	red	142.02 €
8012570	silver	142.02 €
8011538	graphite	142.02 €
8012357	lemonyellow	142.02 €
8012380	limegreen	142.02 €
8011539	almond	142.02 €
8012390	pink	142.02 €
8012396	mint	142.02 €
8011540	black	142.02 €
8011541	black matt	142.02 €
8012571	white matt	142.02 €
8011542	graphite matt	142.02 €
8011543	sand matt	142.02 €

Spare parts

8011702	Shell handle, chrome	4.20 €
---------	----------------------	--------

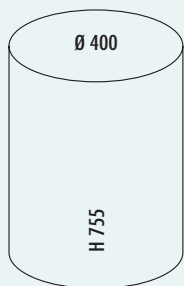

Pushboy

NEW!

- waste capacity 50 litres
- powder-coated sheet steel body
- stainless-steel flap
- chrome-plated plastic handles
- metal insert
- plastic base ring

8011544	white	188.24 €
8012041	red	188.24 €
8012042	nickel silver	188.24 €
8011545	graphite	188.24 €
8012399	lemonyellow	188.24 €
8012560	limegreen	188.24 €
8011546	almond	188.24 €
8012561	pink	188.24 €
8012562	mint	188.24 €
8012563	turquoise	188.24 €
8011547	black	188.24 €
8011548	black matt	188.24 €
8011549	white matt	188.24 €
8011550	graphite matt	188.24 €
8011551	sand matt	188.24 €
8011618	silver	188.24 €
8011619	cool grey	188.24 €

Spare parts

8011702	Shell handle, chrome	4.20 €
---------	----------------------	--------

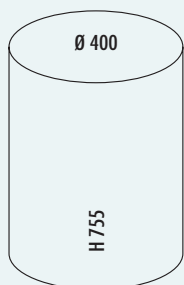

Kickboy

NEW!

- waste capacity 40 litres
- powder-coated sheet steel body
- stainless-steel flap
- chrome-plated plastic handles
- metal insert
- chrome-plated plastic foot pedal
- plastic base ring

8011552	white	238.66 €
8011553	red	238.66 €
8011554	nickel silver	238.66 €
8011555	graphite	238.66 €
8012066	almond	238.66 €
8011556	black	238.66 €

Spare parts

8011702	Shell handle, chrome	4.20 €
---------	----------------------	--------

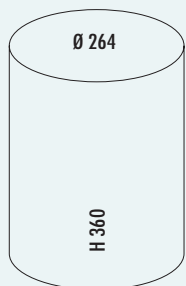

Mini Master

NEW!

- waste capacity 6 litres
- powder-coated sheet steel body
- stainless-steel flap
- plastic insert
- chrome-plated plastic foot pedal
- plastic base ring

8036165	white	95.80 €
8036160	black	95.80 €
8012188	black matt	95.80 €
8012189	white matt	95.80 €
8012190	graphite matt	95.80 €
8012191	sand matt	95.80 €

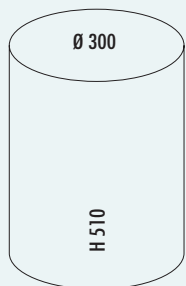

Kickmaster Junior

NEW!

- waste capacity 12 litres
- powder-coated sheet steel body
- stainless-steel flap
- plastic insert
- chrome-plated plastic foot pedal
- plastic base ring

8012293	white	123.53 €
8012192	red	123.53 €
8012193	black matt	123.53 €
8012194	white matt	123.53 €
8012195	graphite matt	123.53 €
8012196	sand matt	123.53 €

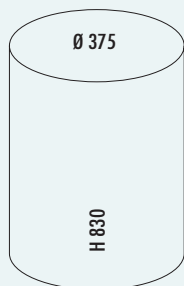

Kickmaster Maxi

NEW!

- waste capacity 40 litres
- powder-coated sheet steel body
- stainless-steel flap
- chrome-plated plastic handles
- metal insert
- chrome-plated plastic foot pedal
- plastic base ring

8011557	white	284.03 €
8011558	red	284.03 €
8011559	nickel silver	284.03 €
8011560	graphite	284.03 €
8011561	almond	284.03 €
8011562	black	284.03 €
8011563	black matt	284.03 €
8011564	white matt	284.03 €
8011565	graphite matt	284.03 €
8011566	sand matt	284.03 €

Spare parts

8011702	Shell handle, chrome	4.20 €
---------	----------------------	--------

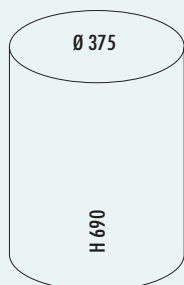

Kickmaster

NEW!

- waste capacity 33 litres
- powder-coated sheet steel body
- stainless-steel flap
- chrome-plated plastic handles
- metal insert
- chrome-plated plastic foot pedal
- plastic base ring

8011567	white	278.15 €
8011568	red	278.15 €
8011569	nickel silver	278.15 €
8011570	graphite	278.15 €
8012564	lemonyellow	278.15 €
8012565	lemonyellow	278.15 €
8012204	almond	278.15 €
8012566	pink	278.15 €
8012567	mint	278.15 €
8011571	black	278.15 €
8011572	black matt	278.15 €
8011573	white matt	278.15 €
8011574	graphite matt	278.15 €
8011575	sand matt	278.15 €
8011668	cool grey	278.15 €

Spare parts

8011702	Shell handle, chrome	4.20 €
---------	----------------------	--------

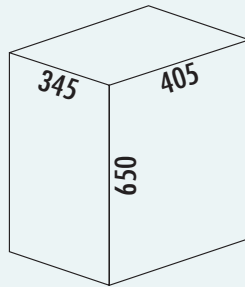

Big Double Boy

NEW!

- waste capacity 36 (2 x 18) litres
- powder-coated sheet steel body
- stainless-steel lid
- plastic insert
- stainless-steel foot pedal

8011694	red	192.44 €
8011695	almond	192.44 €
8011696	black matt	192.44 €
8011697	white matt	192.44 €
8011698	graphite matt	192.44 €
8011699	sand matt	192.44 €

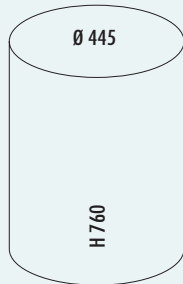

Big Swing

NEW!

- waste capacity 120 litres
- powder-coated sheet steel body
- stainless-steel lid

8011576	red	340.34 €
8011577	nickel silver	340.34 €
8011578	graphite	340.34 €
8011579	black	340.34 €

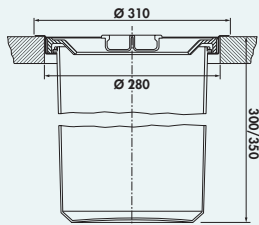

Dassa 2

- Quick and handy – installed directly in the working surface.
Also suitable for flush installation.
- installation dimension Ø 280 mm
 - outside Ø 310 mm

8011059	stainless steel with plastic insert, waste capacity 13 liters	206.64 €
8011101	stainless steel with plastic insert, waste capacity 11 liters	151.26 €

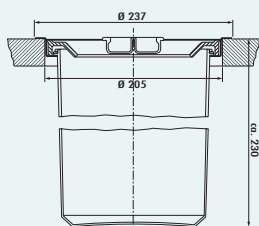

Dassa 4

- Quick and handy – installed directly in the working surface.
Also suitable for flush installation.
- installation dimension Ø 205 mm
 - outside Ø 237 mm
 - waste capacity 5 liters

8011031	stainless steel with plastic insert	127.56 €
8011032	stainless steel with aluminium insert	167.98 €

VIVACE Outdoor

Elegant waste collectors and
floor-standing ashtrays



■ Ashtray	Page 81
■ Ashtray with cover	Page 81
■ Big Ash	Page 81
■ Ashtray 24 with sieve	Page 82
■ Ashtray 30 with sieve	Page 82
■ Ashtray 50 with sieve	Page 82
■ Wall ashtray	Page 83



VIVACE

Outdoor



Where people gather outdoors, they often smoke. The **VIVACE ashtrays** have enough volume, look smart and, with their stability and functionality, are ideal for outdoor use. In shopping arcades, entrance areas, airports or restaurants, they also act as elegant eye-catchers and turn the necessary into something special.

The **VIVACE ashtrays** are available in either high-quality powder-coated sheet steel or stainless steel. With its attractive appearance and reliable functionality, the stand-alone model invites people to use it.

The wall ashtray in letterbox format for wall mounting can be locked on the side with a triangular socket wrench and is therefore particularly vandal-proof.

Good idea: the model **Big Ash** with an ashtray for filling with sand, sieve insert and 120 litres of waste volume. The large, coated roof protects the ashtray from the rain.

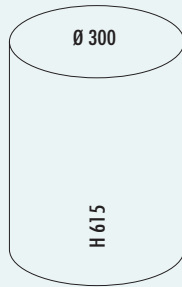

Ashtray

NEW!

- waste capacity 15 litres
- stainless-steel body
- weatherproof

8012186 stainless steel

83.19 €

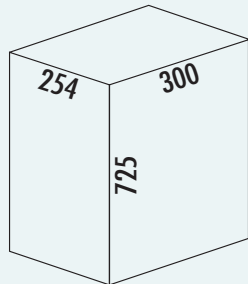

Ashtray with cover

NEW!

- waste capacity 19 litres
- stainless-steel body
- stainless-steel insert
- with sieve
- weatherproof

8012187 stainless steel matt

289.92 €

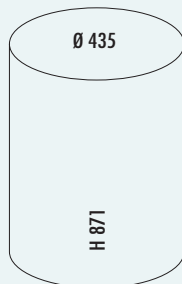

Big Ash

NEW!

- waste capacity 120 litres
- powder-coated sheet steel body
- **without insert**
- with sieve and interior fastening for bin liners

8011691 red

331.93 €

8011692 nickel silver

331.93 €

8011693 graphite

331.93 €



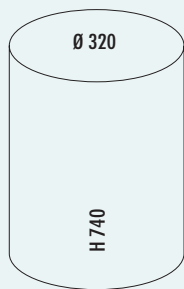

Ashtray 24 with sieve

NEW!

- waste capacity 24 litres
- powder-coated sheet steel body
- metal insert

8012184 red	180.67 €
8012185 nickel silver	180.67 €

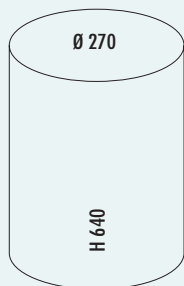

Ashtray 30 with sieve

NEW!

- waste capacity 30 litres
- powder-coated sheet steel body
- without insert

8011529 red	126.05 €
8011530 nickel silver	126.05 €
8011531 graphite	126.05 €
8011705 silver	126.05 €
8011706 anthracite	126.05 €

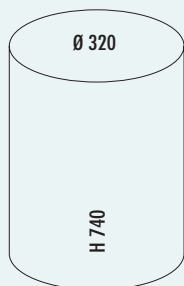

Ashtray 50 with sieve

NEW!

- waste capacity 50 litres
- powder-coated sheet steel body
- without insert

8012182 red	157.14 €
8012183 nickel silver	157.14 €
8011708 silver	157.14 €
8011707 anthracite	157.14 €



Wall ashtray

NEW!

- lockable
- 285 x 232 x 62 mm (H x W x D)

8011700 silver

63.03 €

VIVACE Storage

All-round container for
all provisions



■ Breadboy	Page 86
Mini Grandy	Page 86
Single Grandy	Page 86
Grandy	Page 87
Single Elly	Page 87
Canister Classic Line	Page 87
Cookie box Classic Line	Page 88
Paper roll holder	Page 88
Christmas edition	Page 89



VIVACE

Storage



The fresh and hygienic storage of bread, rolls, pastries and many other things requires suitable storage containers. **VIVACE** provides intelligent optimised solutions!

The swing lid of the classic **Bread-boy** glides almost soundlessly up and back. The generous opening makes the handling of baked goods easier, while small ventilation holes provide optimum air circulation to keep them fresh for longer.

Grandy and **Single Grandy** are the ideal bread bins. Solid metal hinges give them reliable stability. Appealing colour combinations and rounded shapes are pleasing to the eye. The smallest model, the **Mini Grandy**, is also ideal for storing jewellery or medicines or for small toys in the children's room.

The retro centrepiece **Single Elly** is the perfect bread bin for small kitchens. The storage and biscuit tins of the **Classic Line** model provide an attractive companion in shape and colour. Their tight-fitting lids are ideal for storing perishable provisions such as coffee, sugar or flour.

Kitchen rolls and toilet rolls are stored stylishly and ready to use in the **VIVACE paper roll holder**. 11 colours make for a lively selection. And, as with all **VIVACE containers**, the high-quality powder-coated sheet steel makes for indestructible durability.

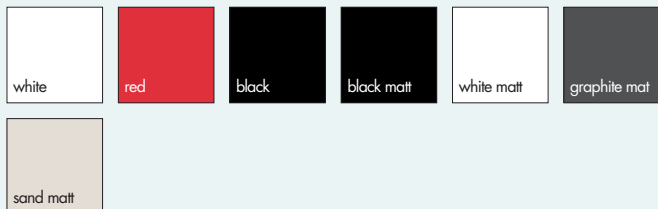
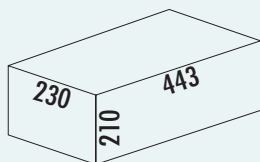

Breadboy

NEW!

Bread box. With rattle-free swivelling lid.
— 210 x 443 x 230 mm (H x W x D)

8012295	white	96.64 €
8012205	red	96.64 €
8012294	black	96.64 €
8012206	black matt	96.64 €
8012207	white matt	96.64 €
8012208	graphite matt	96.64 €
8012209	sand matt	96.64 €

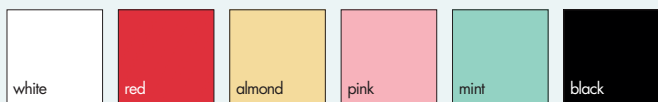
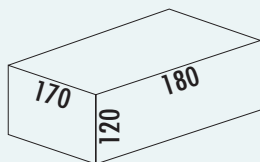

Mini Grandy

NEW!

Bread box.
— 120 x 180 x 170 mm (H x W x D)

8012291	white	36.97 €
8012625	red	36.97 €
8012626	almond	36.97 €
8036154	pink	36.97 €
8036155	mint	36.97 €
8036156	black	36.97 €

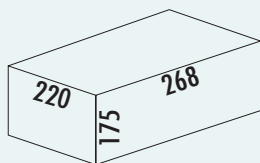

Single Grandy

NEW!

Bread box.
— 175 x 268 x 220 mm (H x W x D)

8012211	white matt	72.27 €
8012210	red	72.27 €
8012213	almond	72.27 €
8036157	pink	72.27 €
8036158	mint	72.27 €
8012290	cool grey	72.27 €
8036159	black	72.27 €
8012214	black matt	72.27 €
8012215	white matt	72.27 €
8012216	graphite matt	72.27 €
8012217	sand matt	72.27 €

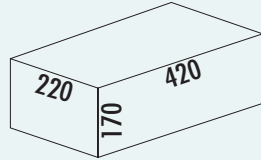

Grandy

NEW!

Bread box.
— 170 x 420 x 220 mm (H x W x D)

8036031	white	96.64 €
8036032	red	96.64 €
8036034	nickel silver	96.64 €
8036147	almond	96.64 €
8036148	pink	96.64 €
8036149	mint	96.64 €
8036123	cool grey	96.64 €
8036120	black matt	96.64 €
8036121	black matt	96.64 €
8036122	white matt	96.64 €
8036124	graphite matt	96.64 €
8036125	sand matt	96.64 €

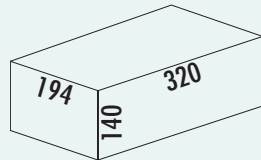

Single Elly

NEW!

Bread box.
— 140 x 320 x 194 mm (H x W x D)

8012296	white	84.03 €
8012218	red	84.03 €
8012219	almond	84.03 €
8012297	black	84.03 €
8012220	black matt	84.03 €
8012222	graphite matt	84.03 €
8012221	white matt	84.03 €
8012223	sand matt	84.03 €

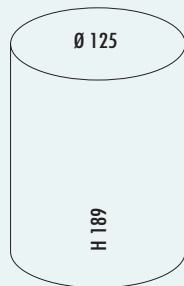

Canister Classic Line

NEW!

— capacity 2 litres
— 189 x 125 x 125 mm (H x W x D)

8012298	white	29.83 €
8012224	red	29.83 €
8012225	almond	29.83 €
8012299	mint	29.83 €
8036145	cool grey	29.83 €
8012226	black	29.83 €
8036144	black matt	29.83 €
8012227	white matt	29.83 €
8012228	graphite matt	29.83 €
8036146	sand matt	29.83 €

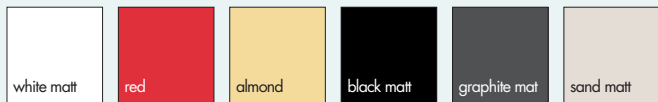
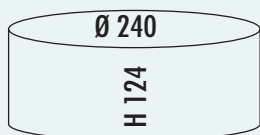

Cookie box Classic Line

NEW!

- capacity 4 litres
- 124 x 240 x 240 mm (H x W x D)

8012238	white matt	37.82 €
8012235	red	37.82 €
8012236	almond	37.82 €
8012237	black matt	37.82 €
8012239	graphite matt	37.82 €
8012240	sand matt	37.82 €

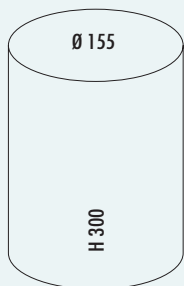

Paper roll holder

NEW!

- for standard kitchen paper rolls or 2-3 toilet paper rolls
- 300 x 155 x 155 mm (H x W x D)

8036150	white	29.41 €
8012229	red	29.41 €
8012230	almond	29.41 €
8036151	pink	29.41 €
8012580	cool grey	29.41 €
8036152	warm grey	29.41 €
8036153	black	29.41 €
8012231	black matt	29.41 €
8012232	white matt	29.41 €
8012233	graphite matt	29.41 €
8012234	sable mat	29.41 €

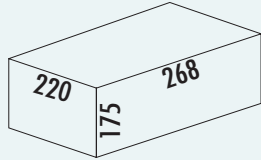

Single Grandy Christmas

NEW!

Bread box.

— 175 x 268 x 220 mm (H x W x D)

8036167	christmas red	72.27 €
8036166	christmas green	72.27 €

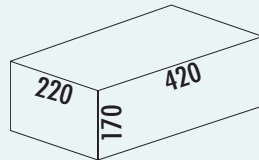

Grandy Christmas

NEW!

Bread box.

— 170 x 420 x 220 mm (H x W x D)

8036168	christmas red	96.64 €
8036169	christmas green	96.64 €

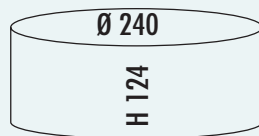

Cookie box Classic Line Christmas

NEW!

— capacity 4 litres

— 124 x 240 x 240 mm (H x W x D)

8036164	christmas red	37.82 €
8036163	christmas green	37.82 €



3031307

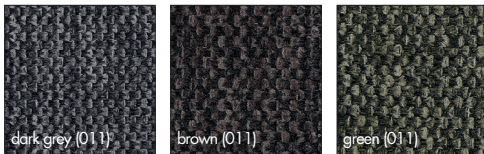

Famous 1AS

NEW!

Chair with armrests.

- front: seat and backrest fabric (100 % PES, 011) padded with pocket spring core (RG 28)
- back: Kunstleder dark grey
- abrasion resistance 30.000
- closed backrest
- max. load ca. 150 kg
- rigid or 360° rotatable (automatically returns to original position)
- height to top edge of armrests 68 cm
- width incl. armrests 61 cm
- **seat height 51 cm**
- with plastic floor glides
- assembly required

3031300	frame black matt, rigid, oval, cover dark grey	292.60 €
3031301	frame black matt, rigid, oval, cover brown	292.60 €
3031302	frame black matt, rigid, oval, cover green	292.60 €
3031303	frame black matt, rotatable, round, cover dark grey	320.68 €
3031304	frame black matt, rotatable, round, cover brown	320.68 €
3031305	frame black matt, rotatable, round, cover green	320.68 €
3031306	frame black matt, rotatable, angular, cover dark grey	320.68 €
3031307	frame black matt, rotatable, angular, cover brown	320.68 €
3031308	frame black matt, rotatable, angular, cover green	320.68 €

Expected to be available from February 2025.



3031315

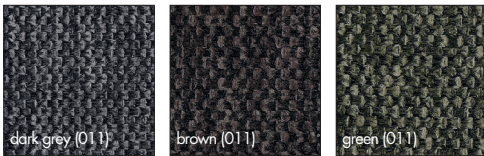

Famous 1S

NEW!

Chair.

- front: seat and backrest fabric (100 % PES, 011) padded with pocket spring core (RG 28)
- back: Kunstleder dark grey
- abrasion resistance 30.000
- closed backrest
- max. load ca. 150 kg
- rigid or 360° rotatable (automatically returns to original position)
- **seat height 51 cm**
- with plastic floor glides
- assembly required

3031309	frame black matt, rigid, oval, cover dark grey	256.94 €
3031310	frame black matt, rigid, oval, cover brown	256.94 €
3031311	frame black matt, rigid, oval, cover green	256.94 €
3031312	frame black matt, rotatable, round, cover dark grey	285.02 €
3031313	frame black matt, rotatable, round, cover brown	285.02 €
3031314	frame black matt, rotatable, round, cover green	285.02 €
3031315	frame black matt, rotatable, angular, cover dark grey	285.02 €
3031316	frame black matt, rotatable, angular, cover brown	285.02 €
3031317	frame black matt, rotatable, angular, cover green	285.02 €

Expected to be available from February 2025.



3031339

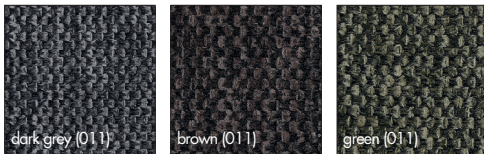

Brezo 1AS

NEW!

Chair with armrests.

- front: seat and backrest fabric (100 % PES, 011) padded with pocket spring core (RG 28)
- back: Kunstleder dark grey
- abrasion resistance 30.000
- closed backrest
- max. load ca. 150 kg
- rigid or 360° rotatable (automatically returns to original position)
- height to top edge of armrests 68 cm
- width incl. armrests 59 cm
- **seat height 48 cm**
- with plastic floor glides
- assembly required

3031336 frame black matt, rigid, oval, cover dark grey	255.46 €
3031337 frame black matt, rigid, oval, cover brown	255.46 €
3031338 frame black matt, rigid, oval, cover green	255.46 €
3031339 frame black matt, rotatable, round, cover dark grey	284.03 €
3031340 frame black matt, rotatable, round, cover brown	284.03 €
3031341 frame black matt, rotatable, round, cover green	284.03 €
3031342 frame black matt, rotatable, angular, cover dark grey	284.03 €
3031343 frame black matt, rotatable, angular, cover brown	284.03 €
3031344 frame black matt, rotatable, angular, cover green	284.03 €

Expected to be available from February 2025.



3031350

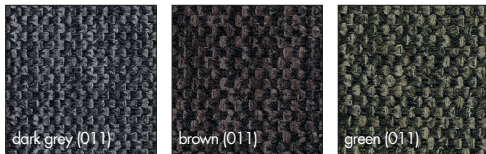
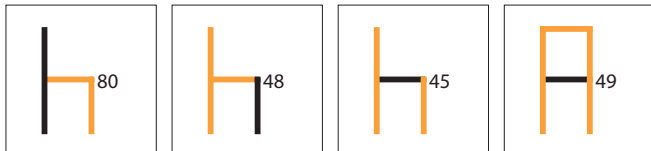

Brezo 1S

NEW!

Chair.

- front: seat and backrest fabric (100 % PES, 011) padded with pocket spring core (RG 28)
- back: Kunstleder dark grey
- abrasion resistance 30.000
- closed backrest
- max. load ca. 150 kg
- rigid or 360° rotatable (automatically returns to original position)
- **seat height 48 cm**
- with plastic floor glides
- assembly required

3031345	frame black matt, rigid, oval, cover dark grey	219.33 €
3031346	frame black matt, rigid, oval, cover brown	219.33 €
3031347	frame black matt, rigid, oval, cover green	219.33 €
3031348	frame black matt, rotatable, round, cover dark grey	247.06 €
3031348	frame black matt, rotatable, round, cover dark grey	247.06 €
3031350	frame black matt, rotatable, round, cover green	247.06 €
3031351	frame black matt, rotatable, angular, cover dark grey	247.06 €
3031352	frame black matt, rotatable, angular, cover brown	247.06 €
3031353	frame black matt, rotatable, angular, cover green	247.06 €

Expected to be available from February 2025.



3031372

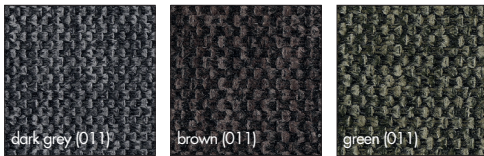

Stella 1AS

NEW!

Chair with armrests.

- front: seat and backrest fabric (100 % PES, 011) padded with pocket spring core (RG 28)
- back: Kunstleder dark grey
- abrasion resistance 30.000
- closed backrest
- max. load ca. 150 kg
- rigid or 360° rotatable (automatically returns to original position)
- height to top edge of armrests 65 cm
- width incl. armrests 60 cm
- **seat height 47 cm**
- with plastic floor glides
- assembly required

3031372 frame black matt, rigid, oval, cover dark grey	274.83 €
3031373 frame black matt, rigid, oval, cover brown	274.83 €
3031374 frame black matt, rigid, oval, cover green	274.83 €
3031375 frame black matt, rotatable, round, cover dark grey	302.91 €
3031376 frame black matt, rotatable, round, cover brown	302.91 €
3031377 frame black matt, rotatable, round, cover green	302.91 €
3031378 frame black matt, rotatable, angular, cover dark grey	302.91 €
3031379 frame black matt, rotatable, angular, cover brown	302.91 €
3031380 frame black matt, rotatable, angular, cover green	302.91 €

Expected to be available from February 2025.



3031383



Stella 1S

NEW!

Chair.

- front: seat and backrest fabric (100 % PES, 011) padded with pocket spring core (RG 28)
- back: Kunstleder dark grey
- abrasion resistance 30.000
- closed backrest
- max. load ca. 150 kg
- rigid or 360° rotatable (automatically returns to original position)
- **seat height 47 cm**
- with plastic floor glides
- assembly required

3031381	frame black matt, rigid, oval, cover dark grey	252.34 €
3031382	frame black matt, rigid, oval, cover brown	252.34 €
3031383	frame black matt, rigid, oval, cover green	252.34 €
3031384	frame black matt, rotatable, round, cover dark grey	280.42 €
3031385	frame black matt, rotatable, round, cover brown	280.42 €
3031386	frame black matt, rotatable, round, cover green	280.42 €
3031387	frame black matt, rotatable, angular, cover dark grey	280.42 €
3031388	frame black matt, rotatable, angular, cover brown	280.42 €
3031389	frame black matt, rotatable, angular, cover green	280.42 €

Expected to be available from February 2025.



Lino 1KT

NEW!

Chair.

- seat and backrest grained artificial leather (100 % PU, 012) padded (RG 28)
- abrasion resistance 50.000
- closed backrest
- max. load ca. 150 kg
- **seat height 48 cm**
- with plastic floor glides
- assembly required

3031486

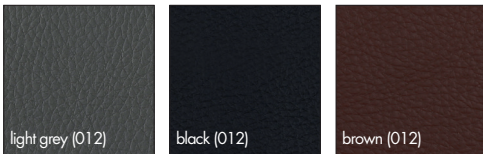

3031486 frame black matt, cover light grey	229.41 €
3031487 frame black matt, cover black	229.41 €
3031488 frame black matt, cover brown	229.41 €

Expected to be available from February 2025.



Lino 1KM

NEW!

- Chair.
- seat and backrest soft artificial leather (100 % PES, 013) padded (RG 28)
 - abrasion resistance 40.000
 - closed backrest
 - max. load ca. 150 kg
 - **seat height 48 cm**
 - with plastic floor glides
 - assembly required

3031491

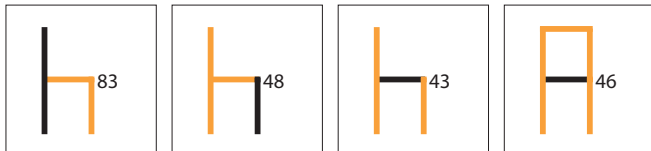

3031489	frame black matt, cover dark khaki	241.18 €
3031490	frame black matt, cover dark grey	241.18 €
3031491	frame black matt, cover light khaki	241.18 €

Expected to be available from February 2025.



Ella 1KM

NEW!

Chair.

- seat and backrest soft artificial leather (100 % PES, 013) padded (RG 28)
- abrasion resistance 40.000
- closed backrest
- max. load ca. 150 kg
- height to top edge of armrests 67 cm
- **seat height 48 cm**
- with plastic floor glides
- assembly required

3031492

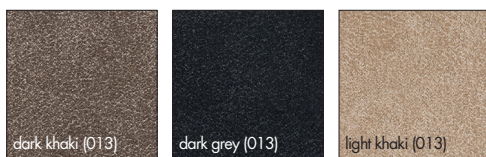

3031492	frame black matt, cover dark khaki	320.17 €
3031493	frame black matt, cover dark grey	320.17 €
3031494	frame black matt, cover light khaki	320.17 €

Expected to be available from February 2025.



3031320



Famous 2AS

NEW!

Stool with armrests.

- front: seat and backrest fabric (100 % PES, 011) padded with pocket spring core (RG 28)
- back Kunstleder dark grey
- abrasion resistance 30.000
- closed backrest
- max. load ca. 140 kg
- rigid or 180° rotatable (automatically returns to original position)
- height to top edge of armrests 82 cm
- width incl. armrests 54 cm
- **seat height 71 cm**
- with plastic floor glides
- assembly required

3031318	frame black matt, rigid, cover dark grey	323.11 €
3031319	frame black matt, rigid, cover brown	323.11 €
3031320	frame black matt, rigid, cover green	323.11 €
3031321	frame black matt, rotatable, cover dark grey	339.07 €
3031322	frame black matt, rotatable, cover brown	339.07 €
3031323	frame black matt, rotatable, cover green	339.07 €

Expected to be available from February 2025.



3031354

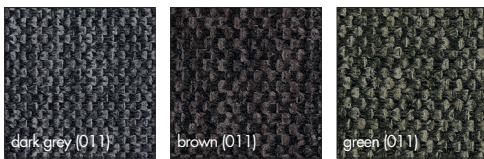

Brezo 2AS

NEW!

Stool with armrests.

- front: seat and backrest fabric (100 % PES, 011) padded with pocket spring core (RG 28)
- back Kunstleder dark grey
- abrasion resistance 30.000
- closed backrest
- max. load ca. 140 kg
- rigid or 180° rotatable (automatically returns to original position)
- height to top edge of armrests 85 cm
- width incl. armrests 55 cm
- **seat height 68 cm**
- with plastic floor glides
- assembly required

3031354	frame black matt, rigid, cover dark grey	307.00 €
3031355	frame black matt, rigid, cover brown	307.00 €
3031356	frame black matt, rigid, cover green	307.00 €
3031357	frame black matt, rotatable, cover dark grey	322.96 €
3031358	frame black matt, rotatable, cover brown	322.96 €
3031359	frame black matt, rotatable, cover green	322.96 €

Expected to be available from February 2025.



3031392

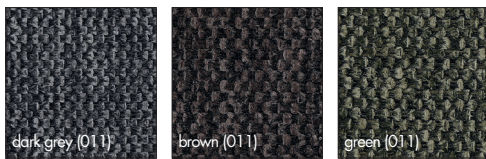

Stella 2AS

NEW!

Stool with armrests.

- front: seat and backrest fabric (100 % PES, 011) padded with pocket spring core (RG 28)
- back Kunstleder dark grey
- abrasion resistance 30.000
- closed backrest
- max. load ca. 140 kg
- rigid or 180° rotatable (automatically returns to original position)
- height to top edge of armrests 83 cm
- width incl. armrests 58 cm
- **seat height 68 cm**
- with plastic floor glides
- assembly required

3031390	frame black matt, rigid, cover dark grey	322.69 €
3031391	frame black matt, rigid, cover brown	322.69 €
3031392	frame black matt, rigid, cover green	322.69 €
3031393	frame black matt, rotatable, cover dark grey	338.65 €
3031394	frame black matt, rotatable, cover brown	338.65 €
3031395	frame black matt, rotatable, cover green	338.65 €

Expected to be available from February 2025.



3031408

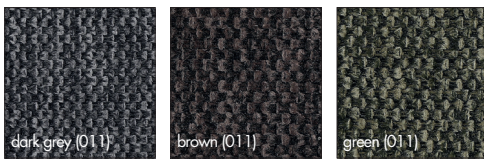

Stella 2S

NEW!

Stool.

- front: seat and backrest fabric (100 % PES, 011) padded with pocket spring core (RG 28)
- back Kunstleder dark grey
- abrasion resistance 30.000
- closed backrest
- max. load ca. 140 kg
- rigid or 180° rotatable (automatically returns to original position)
- **seat height 65 cm**
- with plastic floor glides
- assembly required

3031408	frame black matt, rigid, cover dark grey	296.64 €
3031409	frame black matt, rigid, cover brown	296.64 €
3031410	frame black matt, rigid, cover green	296.64 €
3031411	frame black matt, rotatable, cover dark grey	312.60 €
3031412	frame black matt, rotatable, cover brown	312.60 €
3031413	frame black matt, rotatable, cover green	312.60 €

Expected to be available from February 2025.



3031438/3031441

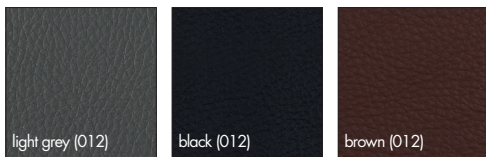

Level 2KT

NEW!

Stool.

- seat and backrest grained artificial leather (100 % PU, 012) padded (RG 28)
- abrasion resistance 50.000
- closed backrest
- max. load ca. 140 kg
- rigid or 180° rotatable (automatically returns to original position)
- **seat height 65 cm**
- with plastic floor glides
- assembly required

3031438 frame black matt, rigid, cover light grey	282.36 €
3031439 frame black matt, rigid, cover black	282.36 €
3031440 frame black matt, rigid, cover brown	282.36 €
3031441 frame black matt, rotatable, cover light grey	298.32 €
3031442 frame black matt, rotatable, cover black	298.32 €
3031443 frame black matt, rotatable, cover brown	298.32 €

Expected to be available from February 2025.



3031457

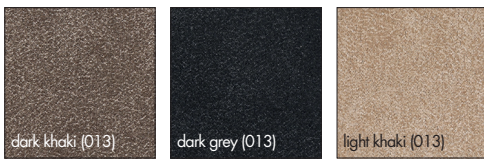
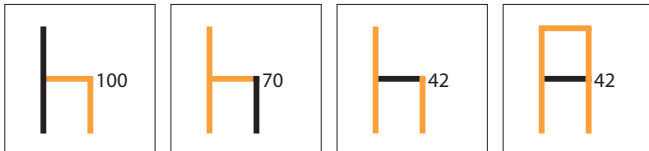

Buono 2KM

NEW!

Stool.

- seat and backrest soft artificial leather (100 % PES, 013) padded (RG 28)
- abrasion resistance 40.000
- closed backrest
- max. load ca. 140 kg
- rigid or 180° rotatable (automatically returns to original position)
- **seat height 70 cm**
- with plastic floor glides
- assembly required

3031456 frame black matt, rigid, cover dark khaki	321.85 €
3031457 frame black matt, rigid, cover dark grey	321.85 €
3031458 frame black matt, rigid, cover light khaki	321.85 €
3031459 frame black matt, rotatable, cover dark khaki	337.81 €
3031460 frame black matt, rotatable, cover dark grey	337.81 €
3031461 frame black matt, rotatable, cover light khaki	337.81 €

Expected to be available from February 2025.



Lino 2KT

NEW!

Stool.

- seat and backrest grained artificial leather (100 % PU, 012) padded (RG 28)
- abrasion resistance 50.000
- closed backrest
- max. load ca. 140 kg
- **seat height 65 cm**
- with plastic floor glides
- assembly required

3031464

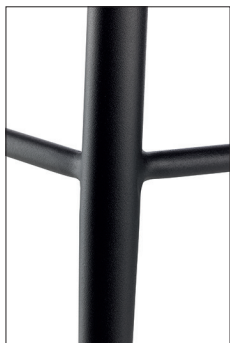
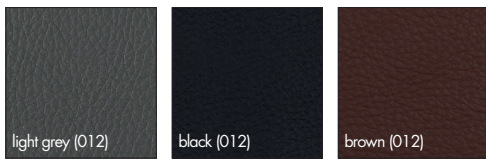

3031462	frame black matt, cover light grey	254.62 €
3031463	frame black matt, cover black	254.62 €
3031464	frame black matt, cover brown	254.62 €

Expected to be available from February 2025.



3031465

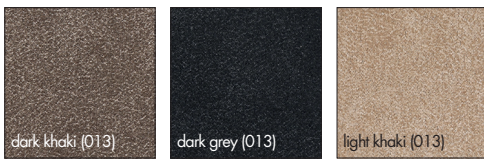

Lino 2KM

NEW!

Stool.

- seat and backrest soft artificial leather (100 % PES, 013) padded (RG 28)
- abrasion resistance 40.000
- closed backrest
- max. load ca. 140 kg
- **seat height 65 cm**
- with plastic floor glides
- assembly required

3031465 frame black matt, cover dark khaki	270.59 €
3031466 frame black matt, cover dark grey	270.59 €
3031467 frame black matt, cover light khaki	270.59 €

Expected to be available from February 2025.



3031468

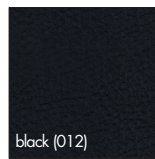

Felice 2KT

NEW!

Stool.

- seat and backrest grained artificial leather (100 % PU, 012) padded (RG 28)
- abrasion resistance 50.000
- closed backrest
- max. load ca. 140 kg
- **seat height 64 cm**
- with plastic floor glides
- assembly required

3031468	frame black matt, cover light grey	295.80 €
3031469	frame black matt, cover black	295.80 €
3031470	frame black matt, cover brown	295.80 €

Expected to be available from February 2025.



Felice 2KM

NEW!

Stool.

- seat and backrest soft artificial leather (100 % PES, 013) padded (RG 28)
- abrasion resistance 40.000
- closed backrest
- max. load ca. 140 kg
- **seat height 64 cm**
- with plastic floor glides
- assembly required

3031471

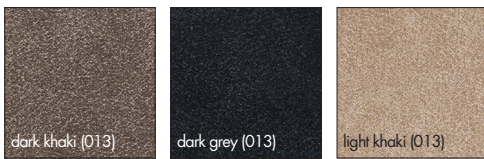

3031471 frame black matt, cover dark khaki	299.16 €
3031472 frame black matt, cover dark grey	299.16 €
3031473 frame black matt, cover light khaki	299.16 €

Expected to be available from February 2025.



3031479

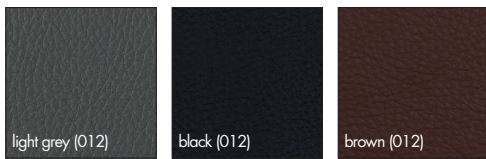

Bringo 2KT

NEW!

Stool.

- seat and backrest grained artificial leather (100 % PU, 012) padded (RG 28)
- abrasion resistance 50.000
- closed backrest
- max. load ca. 140 kg
- **seat height 68 cm**
- with plastic floor glides
- assembly required

3031474 frame black matt, cover light grey	299.16 €
3031475 frame black matt, cover black	299.16 €
3031476 frame black matt, cover brown	299.16 €
3031477 frame stainless-steel coloured, cover light grey	299.16 €
3031478 frame stainless-steel coloured, cover black	299.16 €
3031479 frame stainless-steel coloured, cover brown	299.16 €

Expected to be available from February 2025.



3031481

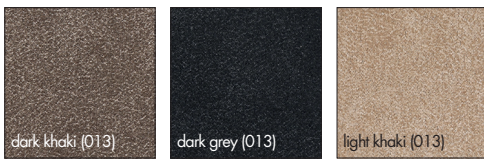
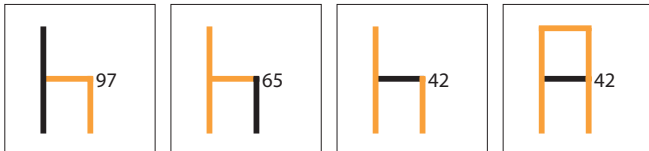

Daimo 2KM

NEW!

Stool.

- seat and backrest soft artificial leather (100 % PES, 013) padded (RG 28)
- abrasion resistance 40.000
- closed backrest
- max. load ca. 140 kg
- **seat height 65 cm**
- with plastic floor glides
- assembly required

3031480 frame black matt, cover dark khaki	295.80 €
3031481 frame black matt, cover dark grey	295.80 €
3031482 frame black matt, cover light khaki	295.80 €
3031483 frame stainless-steel coloured, cover dark khaki	295.80 €
3031484 frame stainless-steel coloured, cover dark grey	295.80 €
3031485 frame stainless-steel coloured, cover light khaki	295.80 €

Expected to be available from February 2025.



3031324

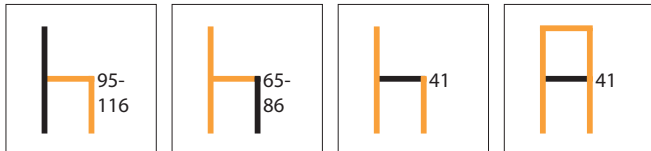

Famous AS

NEW!

Stool with armrests.

- variable height adjustment
- front: seat and backrest fabric (100 % PES, 011) padded with pocket spring core (RG 28)
- back Kunstleder dark grey
- abrasion resistance 30.000
- closed backrest
- max. load ca. 130 kg
- 360° rotatable
- height to top edge of armrests 76–97 cm
- width incl. armrests 52 cm
- **seat height adjustable from 65–86 cm**
- with felt glides
- assembly required

3031324	frame black matt, angular, cover dark grey	452.52 €
3031325	frame black matt, angular, cover brown	452.52 €
3031326	frame black matt, angular, cover green	452.52 €
3031330	frame stainless-steel coloured, angular, cover dark grey	452.52 €
3031331	frame stainless-steel coloured, angular, cover brown	452.52 €
3031332	frame stainless-steel coloured, angular, cover green	452.52 €
3031327	frame black matt, round, cover dark grey	447.48 €
3031328	frame black matt, round, cover brown	447.48 €
3031329	frame black matt, round, cover green	447.48 €
3031333	frame stainless-steel coloured, round, cover dark grey	447.48 €
3031334	frame stainless-steel coloured, round, cover brown	447.48 €
3031335	frame stainless-steel coloured, round, cover green	447.48 €

Expected to be available from February 2025.



3031364

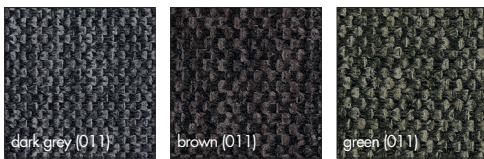
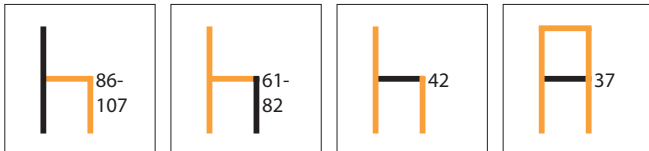

Brezo AS

NEW!

- Stool with armrests.
- variable height adjustment
 - front: seat and backrest fabric (100 % PES, 011) padded with pocket spring core (RG 28)
 - back Kunstleder dark grey
 - abrasion resistance 30.000
 - closed backrest
 - max. load ca. 130 kg
 - 360° rotatable
 - height to top edge of armrests 77-98 cm
 - width incl. armrests 53 cm
 - **seat height adjustable from 61-82 cm**
 - with felt glides
 - assembly required

3031360 frame black matt, angular, cover dark grey	436.41 €
3031361 frame black matt, angular, cover brown	436.41 €
3031362 frame black matt, angular, cover green	436.41 €
3031366 frame stainless-steel coloured, angular, cover dark grey	436.41 €
3031367 frame stainless-steel coloured, angular, cover brown	436.41 €
3031368 frame stainless-steel coloured, angular, cover green	436.41 €
3031363 frame black matt, round, cover dark grey	431.37 €
3031364 frame black matt, round, cover brown	431.37 €
3031365 frame black matt, round, cover green	431.37 €
3031369 frame stainless-steel coloured, round, cover dark grey	431.37 €
3031370 frame stainless-steel coloured, round, cover brown	431.37 €
3031371 frame stainless-steel coloured, round, cover green	431.37 €

Expected to be available from February 2025.



3031405

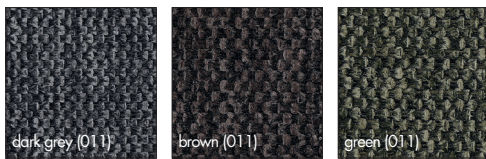

Stella AS

NEW!

- Stool with armrests.
- variable height adjustment
 - front: seat and backrest fabric (100 % PES, 011) padded with pocket spring core (RG 28)
 - back Kunstleder dark grey
 - abrasion resistance 30.000
 - closed backrest
 - max. load ca. 130 kg
 - 360° rotatable
 - height to top edge of armrests 78–99 cm
 - width incl. armrests 57 cm
 - **seat height adjustable from 61–82 cm**
 - with felt glides
 - assembly required

3031396	frame black matt, angular, cover dark grey	452.10 €
3031397	frame black matt, angular, cover brown	452.10 €
3031398	frame black matt, angular, cover green	452.10 €
3031402	frame stainless-steel coloured, angular, cover dark grey	452.10 €
3031403	frame stainless-steel coloured, angular, cover brown	452.10 €
3031404	frame stainless-steel coloured, angular, cover green	452.10 €
3031399	frame black matt, round, cover dark grey	447.06 €
3031400	frame black matt, round, cover brown	447.06 €
3031401	frame black matt, round, cover green	447.06 €
3031405	frame stainless-steel coloured, round, cover dark grey	447.06 €
3031406	frame stainless-steel coloured, round, cover brown	447.06 €
3031407	frame stainless-steel coloured, round, cover green	447.06 €

Expected to be available from February 2025.



3031414

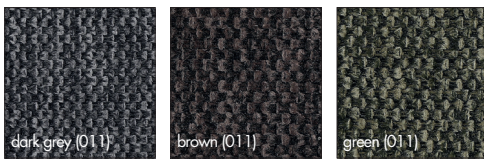
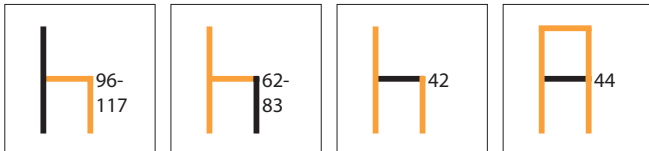

Stella S

NEW!

Stool.

- variable height adjustment
- front: seat and backrest fabric (100 % PES, 011) padded with pocket spring core (RG 28)
- back Kunstleder dark grey
- abrasion resistance 30.000
- closed backrest
- max. load ca. 130 kg
- 360° rotatable
- **seat height adjustable from 62-83 cm**
- with felt glides
- assembly required

3031414 frame black matt, angular, cover dark grey	426.05 €
3031415 frame black matt, angular, cover brown	426.05 €
3031416 frame black matt, angular, cover green	426.05 €
3031420 frame stainless-steel coloured, angular, cover dark grey	426.05 €
3031421 frame stainless-steel coloured, angular, cover brown	426.05 €
3031422 frame stainless-steel coloured, angular, cover green	426.05 €
3031417 frame black matt, round, cover dark grey	421.01 €
3031418 frame black matt, round, cover brown	421.01 €
3031419 frame black matt, round, cover green	421.01 €
3031423 frame stainless-steel coloured, round, cover dark grey	421.01 €
3031424 frame stainless-steel coloured, round, cover brown	421.01 €
3031425 frame stainless-steel coloured, round, cover green	421.01 €

Expected to be available from February 2025.



3031437

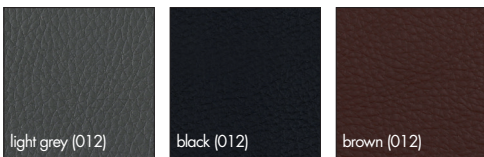
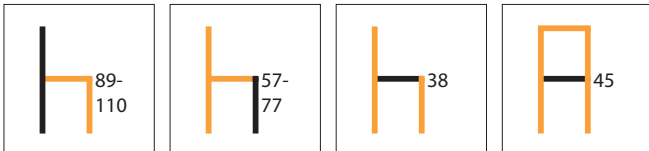

Level KT

NEW!

- Stool.
- variable height adjustment
 - seat and backrest grained artificial leather (100 % PU, 012) padded (RG 28)
 - abrasion resistance 50.000
 - closed backrest
 - max. load ca. 130 kg
 - 360° rotatable
 - **seat height 57–77 cm**
 - with felt glides
 - assembly required

3031426	frame black matt, angular, cover light grey	411.77 €
3031427	frame black matt, angular, cover black	411.77 €
3031428	frame black matt, angular, cover brown	411.77 €
3031432	frame stainless-steel coloured, angular, cover light grey	411.77 €
3031433	frame stainless-steel coloured, angular, cover black	411.77 €
3031434	frame stainless-steel coloured, angular, cover brown	411.77 €
3031429	frame black matt, round, cover light grey	406.73 €
3031430	frame black matt, round, cover black	406.73 €
3031431	frame black matt, round, cover brown	406.73 €
3031435	frame stainless-steel coloured, round, cover light grey	406.73 €
3031436	frame stainless-steel coloured, round, cover black	406.73 €
3031437	frame stainless-steel coloured, round, cover brown	406.73 €

Expected to be available from February 2025.



3031444

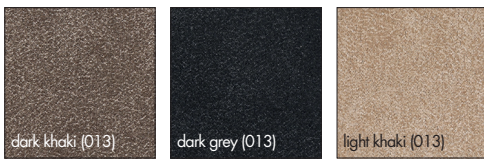
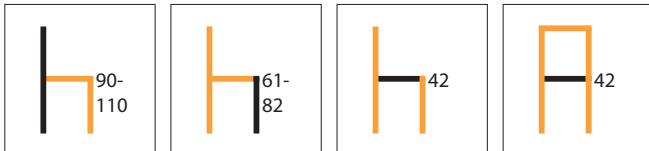

Buono KM

NEW!

Stool.

- variable height adjustment
- seat and backrest soft artificial leather (100 % PES, **013**) padded (RG 28)
- abrasion resistance 40.000
- closed backrest
- max. load ca. 130 kg
- 360° rotatable
- **seat height 61–82 cm**
- with felt glides
- assembly required

3031444 frame black matt, angular, cover dark khaki	451.26 €
3031445 frame black matt, angular, cover dark grey	451.26 €
3031446 frame black matt, angular, cover light khaki	451.26 €
3031450 frame stainless-steel coloured, angular, cover dark khaki	451.26 €
3031451 frame stainless-steel coloured, angular, cover dark grey	451.26 €
3031452 frame stainless-steel coloured, angular, cover light khaki	451.26 €
3031447 frame black matt, round, cover dark khaki	446.22 €
3031448 frame black matt, round, cover dark grey	446.22 €
3031449 frame black matt, round, cover light khaki	446.22 €
3031453 frame stainless-steel coloured, round, cover dark khaki	446.22 €
3031454 frame stainless-steel coloured, round, cover dark grey	446.22 €
3031455 frame stainless-steel coloured, round, cover light khaki	446.22 €

Expected to be available from February 2025.

General Terms of Sale B2B

Version 01/2024

I. Scope of application

1. The following Terms of Sale shall apply for all contracts concluded between the purchaser and us concerning the delivery of goods if the purchaser is a company (§ 14 German Civil Code [Bürgerlichesgesetzbuch, BGB]). These Terms also apply for all future contracts concerning the delivery of goods even if they are not expressly mentioned again. Conflicting terms of the purchaser that we do not expressly recognize are not binding for us even if we do not expressly contradict such terms. The following Terms of Sale shall also then apply if we carry out the purchaser's order without reservation and with knowledge of the contradictory or differing terms of the purchaser.
2. All agreements that were entered into between the purchaser and us for performing the purchase contracts are documented in writing in the contracts. The parties shall confirm all oral agreements in writing. If contracts are set out in both the German and also a foreign language, in the case of a dispute, the German language version is determinative.

II. Offer and contract conclusion

1. We can accept a purchaser's order that is to be qualified as an offer to conclude a purchase contract within two weeks—for an order in the Naber dealer portal, 5 working days—by transmitting an order confirmation or by sending ordered products within the same time limit. The purchaser is bound to the purchaser's order for this time period.
2. Our offers are subject to change and nonbinding unless we have expressly identified them as binding.
3. All oral and written information concerning possible applications and the suitability of all goods are carried out to the best of our knowledge. However, this information only represents our historical experience, which cannot be deemed to be consistently warranted. This information does not form the basis for any claims against us. In particular, the purchaser is not relieved of the duty of ensuring by means of the purchaser's own inspection that the goods are suitable for the purchaser's intended use.
4. We reserve all rights of ownership, copyright and other industrial property rights in images, calculations, drawings, sample books, catalogs and other documents. The purchaser may only transfer these to a third-party with our prior written consent irrespective of whether we have designated these items to be confidential.

III. Payment terms

1. All prices apply ex works without packaging and must be paid in Euros if not otherwise set out in our order confirmation. The statutory value added tax is not included in our prices. This will be separately disclosed in the invoice at the statutory amount on the date of invoicing.
2. The purchase price is due 10 days after the invoice is sent (invoice date) less a 2% discount, otherwise net (without discount) 30 days after the invoice date provided that no different payment target follows from the order confirmation. A payment is not deemed to have taken place until the funds are available for our use. In the event of payments by check, the payment is not deemed to have taken place until the check is cashed. For new customers we reserve the right to deliver against cash on delivery less a 2% discount. For orders with a value of goods up to € 50.00 net, we reserve a minimum quantity surcharge of € 6.50. In the case of a contract included with an agreement of „advance payment“, the purchase price is due 10 days after the invoice date.
3. If the purchaser is in default in making payment, the statutory provisions shall apply (§ 288 BGB).
4. The purchaser is only entitled to set-off, even if a notice of defects or counterclaims are asserted, if the counterclaims have been conclusively adjudicated or are undisputed. The purchaser is only authorized to exercise a right of retention if the counterclaim is based on the same contractual relationship.
5. We reserve the right to request payment security and/or advance payments.
6. If the purchaser is in default of payment or if there is reasonable doubt concerning purchaser's ability to pay, we are entitled to declare all claims against purchaser as due for payment and/or to retain as yet outstanding deliveries in their entirety or in part or to withdraw from the existing contracts entirely.

IV. Delivery and performance times, liability for delivery delays

1. Delivery dates or time limits that have not been expressly agreed to be binding are solely non-binding declarations. The delivery time stated by us shall not commence prior to complete clarification of the order and clarification of all technical questions. The purchaser must likewise properly and timely fulfill all obligations incumbent upon purchaser.
2. Force majeure cases, e.g. labor disputes, civil unrest as well as other unforeseeable damaging events for which we are not responsible, extend the delivery time period for the duration of the disruption insofar as the disruption demonstrably influences our ability to render the service. This also applies if these circumstances occur for our suppliers. If the disruption lasts for longer than four weeks subsequent to the expiration of the originally agreed scheduled date, each contracting party can withdraw from the contract. The withdrawal extends to the part of the contract not yet fulfilled, unless the partial performance to be provided is not usable by purchaser. No compensatory damage

claims accrue to the purchaser from this situation.

3. If the underlying purchase contract involves a transaction for delivery by a fixed date within the meaning of the BGB or the Commercial Code (Handelsgesetzbuch, HGB), we are liable according to the statutory provisions. The same applies if the purchaser is entitled, as a consequence of a delayed delivery for which we are responsible, to assert the discontinuation of his interest in the further fulfillment of the contract. In this case our liability is limited to the foreseeable, typically occurring damages if the delayed delivery is not based on an intentional violation of the contract for which we are responsible. We shall likewise be liable to the purchaser for delayed delivery according to the statutory provisions if this delay is based on an intentional or grossly negligent violation of the contract for which we are responsible. Our liability is limited to the foreseeable, typically occurring damages if the delayed delivery is not based on an intentional violation of the contract for which we are responsible. In any case the occurrence of a delay requires a reminder notice from purchaser.
4. Otherwise, in the event of a delivery delay for which we are responsible, purchaser can request a flat amount of compensation in the amount of 0.5 % of the value of goods to be delivered, however a maximum of no more than 5 % of the value of goods to be delivered.
5. Any further liability for a delivery delay for which we are responsible is precluded.
6. We are at all times entitled to make partial deliveries and carry out partial performance insofar as this is reasonable for the customer.
7. In the case of an agreement for „advance payment“, we are not obligated to make the delivery until the funds invoiced are available for our use.

V. Transfer of risk, delay in acceptance, shipping/packaging

1. Loading and shipping are at the purchaser's risk. The regulations concerning a sale by delivery to a place other than the place of performance according to § 447 BGB shall apply even if the shipment is undertaken with our means of transport or by our employees.
2. We shall make every effort to take into consideration the wishes and interests of the purchaser with respect to the type of shipment and route; additional expenditures thereby required—also in the case of an agreed freight paid delivery—shall be at the purchaser's expense. A transportation insurance policy shall be concluded for the shipment if the purchaser expressly requests this with the order. The costs shall be billed to the purchaser and separately set out in the invoice.
3. We will not take back transportation packaging and all other packaging according to the packaging regulation; excepted from this are pallets. Purchaser must ensure the disposal of the packaging at its own expense.
4. If the shipment is delayed at the purchaser's request or due to the purchaser's fault, we will then store the goods at the expense and risk of purchaser. In this case a notice of readiness to dispatch is equivalent to shipment.
5. If the purchaser delays acceptance, we are then entitled to request compensation for the resulting damages and any additional expenditures. The same applies if the purchaser culpably violates duties of cooperation. With the occurrence of a delay in acceptance or the delayed payment of a debt on the part of the purchaser, the risk of accidental deterioration and loss of the goods passes to the purchaser.
6. We shall not assume any costs for returns that are not agreed with us in advance in writing or returns that are not expressly recognized as legitimate after evaluation of the reason for the return (e.g. incorrect delivery, defects, etc.). Should we incur costs for returns that are not agreed or not legitimate, we shall bill the purchaser/sender in the amount of the actually incurred third-party costs as well as our own costs.

VI. Warranty/liability

1. We do not assume any warranty for defects that arise due to natural wear and tear, faulty or negligent treatment, improper storage, inappropriate or improper use or nonobservance of the processing and use instructions. If the delivery takes place according to drawings, specifications, samples, etc. of purchaser, the purchaser assumes the risk of their suitability for the intended use.
2. The purchaser's claims for defects shall only exist if purchaser has properly complied with purchaser's duties of inspection and providing notice of defects. Therefore, purchaser is obligated to promptly provide notice of apparent defects in the goods upon receipt. In the case of hidden defects that purchaser cannot ascertain upon receipt of the goods, purchaser must promptly give notice of defects subsequent to their discovery.
3. In the case of a complaint, we are entitled at our option to request that purchaser send us the rejected goods for inspection or for subsequent performance or make the rejected goods available to us. We shall only bear the costs of this shipment in the case of a legitimate complaint.
4. In the case of a defect we are entitled to carry out the subsequent performance of our choice by means of a replacement delivery or by repairing the defective goods within a reasonable grace period. There is no duty of subsequent performance insofar as we are authorized to refuse subsequent performance on the basis of statutory provisions. In our selection of the type of subsequent performance, we must take into consideration the type of defect and the legitimate interests of

the purchaser. We shall bear the expenses necessary for the purpose of subsequent performance. We shall not bear the additional cost that arises thereby that the goods have been transported to a different location than the place of performance or the registered commercial offices of the ordering party unless this transport is in conformity with the intended use of the goods.

5. If the subsequent performance fails, purchaser can elect a decrease in the purchase price (reduction) or declare purchaser's withdrawal from the contract. If the purchaser withdraws from the contract, purchaser is not entitled to an additional claim for compensation for damages unless we are responsible for the defect due to intentional acts or gross negligence. If only part of the delivery of goods is defective, purchaser can only then withdraw from the entire contract if purchaser does not have any interest in the remaining part of the delivery.
6. Purchaser's claim for recourse by virtue of warranty claims and rights arising from consumer goods purchase contracts (§§ 474, 478 BGB), may only be asserted against us by purchaser to the extent that purchaser is obligated to satisfy warranty claims and rights towards purchaser's customers on the basis of statutory provisions. The claim for recourse against us is excluded to the extent that purchaser has a warranty or liability obligation towards purchaser's customers in the absence of a legal obligation, in particular, as a gesture of goodwill or on the basis of special assurances or guarantees of the purchaser.
7. The claims and rights owing to a defect in the goods may only be asserted by purchaser within the warranty period of twelve months after delivery of the goods. This does not apply for claims and rights for which longer notice periods are mandatorily prescribed according to § 438 paragraph 1 No. 2 BGB for construction, and objects for construction (construction materials) or according to § 445b BGB for the recourse claims of a company.
8. We are liable according to statutory provisions for damages to life, the body and health that are based on a negligent or intentional violation of duties by us or our legal representatives or our vicarious agents as well as for damages that are encompassed by liability under the Product Liability Act. We are liable according to statutory provisions for damages that are not comprehended by sentence 1 and that are based on intentional or grossly negligent contract violations as well as deceit by us, our legal representative or our vicarious agents. However, in this case the liability for compensatory damages is limited to foreseeable, typically occurring damages insofar as we, our legal representative or our vicarious agents did not act intentionally. To the extent that we have provided a guarantee of quality and/or durability with reference to the goods or parts thereof, we shall also be liable within the framework of this guarantee. However, for damages that are based on a lack of quality or durability as guaranteed, but that do not occur directly with regard to the goods, we are only then liable if the risk of such damages is obviously comprehended by the guarantee of quality and durability.
9. We are also liable for damages that are caused by simple negligence insofar as the negligence is related to the violation of those contractual obligations the observance of which are of particular importance for achieving the purpose of the contract (material obligations). In this case, however, our liability is restricted to typically foreseeable damages.
10. Any further liability is excluded without considering the legal nature of the claim asserted; this also applies in particular for tort claims, for claims for reimbursement of futile expenditures in place of performance, or for compensation claims for lost profits. Insofar as our liability is excluded or limited, this shall also apply for the personal liability of our personnel, employees, staff, representatives and vicarious agents.
11. Purchaser's compensatory damage claims on account of a defect are time-barred one year after delivery of the goods. This shall not apply in the case of injuries to life, the body, or health for which we, our legal representatives or our vicarious agents are at fault or if we or our legal representatives have acted in an intentional or grossly negligent manner, or if our ordinary vicarious agents have acted intentionally.
12. Our sales representatives and commercial agents are not authorized to make legally binding statements with regard to defects and warranty claims for us.

VII. Retention of Title

1. a) The delivered goods (goods subject to retention of title) remain our property (extended retention of title) until all claims are satisfied against the purchaser, including all outstanding balance claims from a current account to which we are entitled arising from the order and the entire business relationship.
1. b) To the extent that an extended retention of title is not applicable in the country in which the purchaser has its registered office, the delivered goods remain our property (ordinary retention of title) until all claims to which we are entitled against the purchaser from the respective order have been satisfied, including taxes, charges or transportation costs.
2. In the case of purchaser's conduct contrary to the contract, e.g. delayed payment, we are entitled to take back the goods subject to retention of title after setting a reasonable time limit in advance; if it is unnecessary to set a time limit according to the provisions of the law, we are also entitled to demand the return of the goods subject to a retention of title without a grace period. If we take back the goods subject to a retention of title, this represents a withdrawal from the contract. If we levy execution against the goods subject to a retention of title, this is a withdrawal from the contract. We are entitled to realize on the sale of the goods subject to a retention of title subsequent to taking them back. After deducting a reasonable amount for the cost of realizing the sale, the proceeds from the sale shall be settled against the amounts owed to us by purchaser.
3. Purchaser shall treat the goods subject to a retention of title with care and sufficiently insure these

goods at their original value against losses due to fire, water damage and theft. Maintenance and inspection work that become necessary must be timely carried out by purchaser at purchaser's expense.

4. The purchaser is authorized to sell and/or use the goods subject to a retention of title in the ordinary course of business as long as purchaser is not in default in payment. Pledging and transfers by way of security are impermissible. Claims arising from resale of the processed or unprocessed goods subject to a retention of title, or arising for another legal reason (insurance, unlawful acts) with respect to the goods subject to a retention of title (including all outstanding balance claims from a current account) are already transferred by purchaser to us as security in the amount of the final invoice amount (including VAT) for our claims against the purchaser; we hereby accept the assignment. We revocably authorize purchaser to collect the claims assigned to us in the name of purchaser and for purchaser's account. This collection authorization can be revoked at any time if purchaser does not properly comply with purchaser's payment obligations.
5. For the purpose of assigning this claim, purchaser is also not authorized to collect claims by way of factoring unless an obligation of the factoring party is at the same time created to directly effectuate payment of consideration to us in the amount of the claims for as long as our claims against the purchaser exist.
6. Processing or reshaping the goods subject to a retention of title by purchaser shall in any case be undertaken for us. If the goods subject to a retention of title are processed with other items not owned by us, we shall acquire joint ownership in the new item proportional to the value of the goods subject to a retention of title (final invoice amount including value added tax) along with the other processed items on the date of processing. The same shall apply for the new item emerging from the processing as for the goods subject to a retention of title. In the case of the inseparable combination of the goods subject to a retention of title with other items not owned by us, we shall acquire joint ownership in the new item proportional to the value of the goods subject to a retention of title (final invoice amount including value added tax) along with the other combined items on the date on which they are combined. If the purchaser's item is to be viewed as the primary item as a consequence of this combining, the purchaser and we agree that purchaser transfers proportional joint ownership to us in the item; we hereby accept this transfer. Purchaser shall preserve the sole or joint ownership in the item arising in this manner for us.
7. In the event of attachment by third parties against the goods subject to a retention of title, in particular, levies of execution, purchaser shall call attention to our ownership and immediately inform us so that we may enforce our rights of ownership. To the extent that the third-party is not in the position to reimburse us for the court and out-of-court expenses arising in this connection, purchaser is liable therefor.
8. We are obligated to release the security to which we are entitled to the extent that the realizable value of our security exceeds the claims to be secured by more than 10%; in so doing, the selection of the security to be released is at our discretion.

VIII. Images and dimensions

Images, technical information and dimensions in brochures and price lists shall not be deemed to be a binding agreement and not a promised characteristic. These only represent approximate values. Binding information can be provided in an individual case upon request. Special suitability may not be taken from the images and dimensions. We expressly reserve the right to make modifications.

IX. Place of performance, venue, applicable law

1. The place of performance for deliveries and payments (including actions regarding checks and bills of exchange), is, if not otherwise expressly specified, our registered office in Nordhorn.
2. The exclusive local jurisdiction and international court of competent jurisdiction is in the location of our registered office in Nordhorn (Germany). However, we are also authorized to sue the purchaser in purchaser's place of general jurisdiction (domicile or registered office).
3. The business relations between the contracting parties are regulated exclusively according to the law applicable in the Federal Republic of Germany excluding international private law (Introductory Statute to the Civil Code [Einführungsgesetz zum Bürgerlichen Gesetzbuch], EGBGB). The application of the UN Convention on Contracts for the International Sale of Goods is excluded.
4. Should a provision of these general Terms of Sale (or within the framework of other agreements) be or become invalid or unenforceable entirely or in part, this shall not affect the validity of all other provisions or agreements. The contracting parties hereby commit to replace the invalid or unenforceable provision or agreement with a valid or enforceable provision or agreement most closely in conformity with the commercial provisions.
5. The headings for the individual regulations of these delivery and payment terms only serve to provide a better orientation and do not have any independent substantive content and no legal significance.
6. The purchaser's data related to the business transactions with purchaser shall be processed according to the Federal Data Protection Act.

X. Precedence of the German version

If these Terms of Sale exist in different languages, the German version is solely decisive for clarifying questions of interpretation.

Naber GmbH
Managing Directors: Ingrid Naber, Hans-Joachim Naber and Lasse Naber



Naber VIVACE – imaginative, colourful and robust! With the subgroups waste collectors, outdoor and storage

Naber GmbH
Development · Production · Sales

Enschedestr. 24
48529 Nordhorn
Germany
Tel. +49 5921 704-0
Fax +49 5921 704-140

naber@naber.com
www.naber.com

September 2024 EN

Naber[®]
... inspires!