

## Andy colour change LED

Product number: 7063402

Configuration: L 2000 mm, stainless steel coloured

### Configuration options

- 7063400 | L 1000 mm, stainless steel coloured
- 7063401 | L 1000 mm, black
- 7063402 | L 2000 mm, stainless steel coloured
- 7063403 | L 2000 mm, black
- 7063415 | L 2600 mm, black
- 7063418 | L 2600 mm, stainless steel coloured

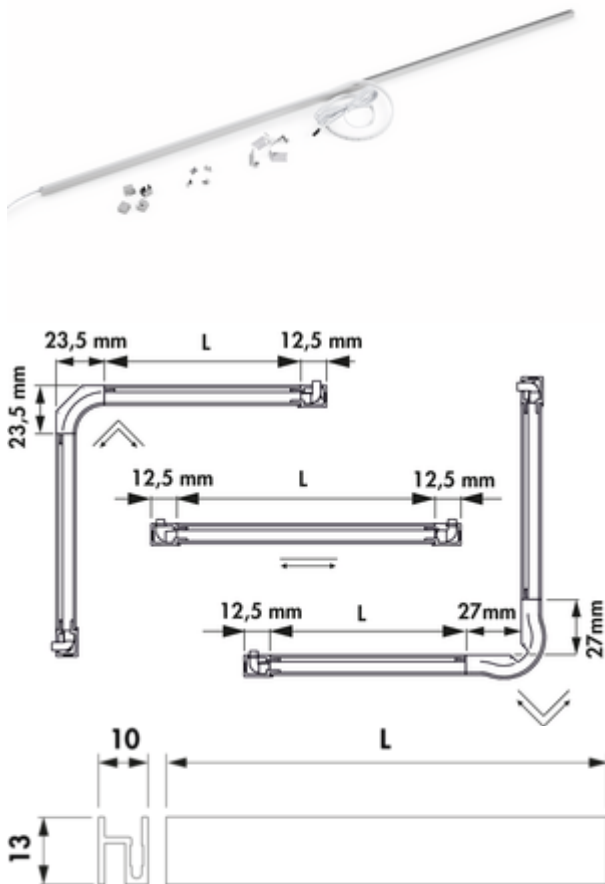

- ✓ Handle strip lighting
- ✓ 2700 K warm white to 6500 K cold white
- ✓ straight

Handle bar lighting. Aluminium housing with plastic corners. LED strip moulded in silicone, **not self-adhesive**, can be shortened every 21 mm. Illumination without visible LED points incl. retaining clips for handle mouldings.

### Single light

- 6.5 watts per metre, 12 V
- continuous adjustment of light colour from **2700 K** warm white to **6500 K** cool white
- max. 80 lumen/watt at **6500 K** cool white
- LED strip, feed on both sides
- 2000 mm supply cable on both sides
- incl. 4 end caps (2 x left, 2 x right)
- incl. 8 clips (2 x 4 pieces)

This product contains a light source of energy efficiency class G.



[more infos...](#)

### Technical data

Article type	Luminaire	Colour temperature	2700 K warm white to 6500 K cold white
Width	2.000 mm	Colour temperature adjustable	stepless
Energy efficiency class	G	Illuminant type	LED
Material housing	aluminium	Light yield	max. 80 lumen/watt at 6500 K cold white
Certification	CE MM sign F-sign	Connection	On both sides
Shortenability	may be shortened every 21 mm	Homogeneous light field without visible LED points	Yes
Shape	straight	Design	Handle strip lighting
Length of the supply line (primary)	2.000 mm	Power per metre	6.5 watt/meter
More parts	incl. holding clamps incl. 4 end caps incl. 8 clips (2 x 4 pieces)		