

Kreta square foot aluminium

Product number: 3013012

Configuration: stainless steel coloured, H 870 mm

Configuration options

3013010 | stainless steel coloured, H 700 mm
 3013012 | stainless steel coloured, H 870 mm
 3013013 | stainless steel coloured, H 1100 mm
 3013110 | black matt, H 700 mm
 3013112 | black matt, H 870 mm
 3013113 | black matt, H 1100 mm

- ✓ Support foot
- ✓ Material: aluminium
- ✓ square

Supporting foot. Sturdy square aluminium profile. Suitable for attachment tables, but not for free standing tables, may not be shortened.

- tube 50 x 50 mm
- height (plus 10 mm height adjustment)
- load-bearing capacity ca. 150 kg

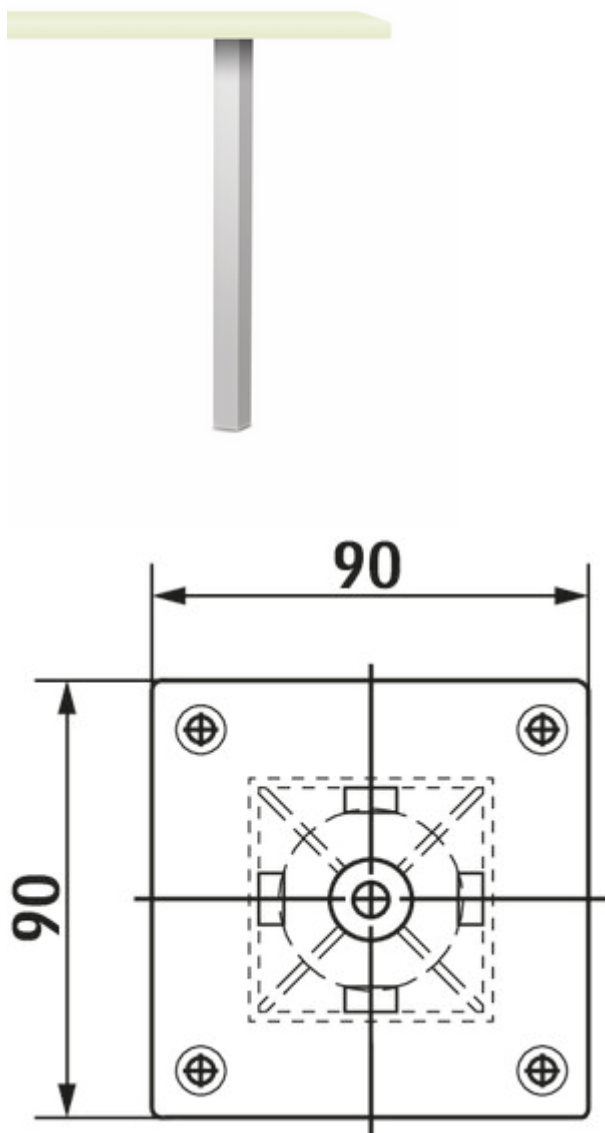

[more infos...](#)

Technical data

Article type	Support foot	With mounting plate	Yes
Width	90 mm	Carrying capacity	ca. 150 kg
Material	aluminium	Tube dimension	50 x 50 mm
Properties	cannot be shortened	Height adjustment	10 mm
Note	not suitable for free-standing tables	Support element version	straight
Suitable for	attachment tables	Dimensions support surface	90 x 90 mm
Shape	square		

Recommendations

3021190	Kreta 3 slanted, Console, stainless steel coloured, H 235 mm
3021193	Kreta 3 slanted, Console, black matt, H 235 mm
3023022	Kreta 1 slanted, Console, stainless steel coloured, H 190 mm
3023023	Kreta 1 slanted, Console, stainless steel coloured, H 230 mm
3023028	Kreta 1 slanted, Console, stainless steel coloured, H 170 mm
3023030	Kreta 1 slanted, Console, black matt, H 170 mm
3023031	Kreta 1 slanted, Console, black matt, H 190 mm
3023032	Kreta 1 slanted, Console, black matt, H 230 mm
3023026	Kreta 2 straight, Console, stainless steel coloured, H 190 mm
3023027	Kreta 2 straight, Console, stainless steel coloured, H 230 mm
3023029	Kreta 2 straight, Console, stainless steel coloured, H 170 mm
3023033	Kreta 2 straight, Console, black matt, H 170 mm
3023034	Kreta 2 straight, Console, black matt, H 190 mm
3023035	Kreta 2 straight, Console, black matt, H 230 mm

Dimensional sketch (PDF)

