

Kreta 2 straight

Product number: 3023034

Configuration: black matt, H 190 mm

Configuration options

3023026 | stainless steel coloured, H 190 mm

3023027 | stainless steel coloured, H 230 mm

3023029 | stainless steel coloured, H 170 mm

3023033 | black matt, H 170 mm

3023034 | black matt, H 190 mm

3023035 | black matt, H 230 mm

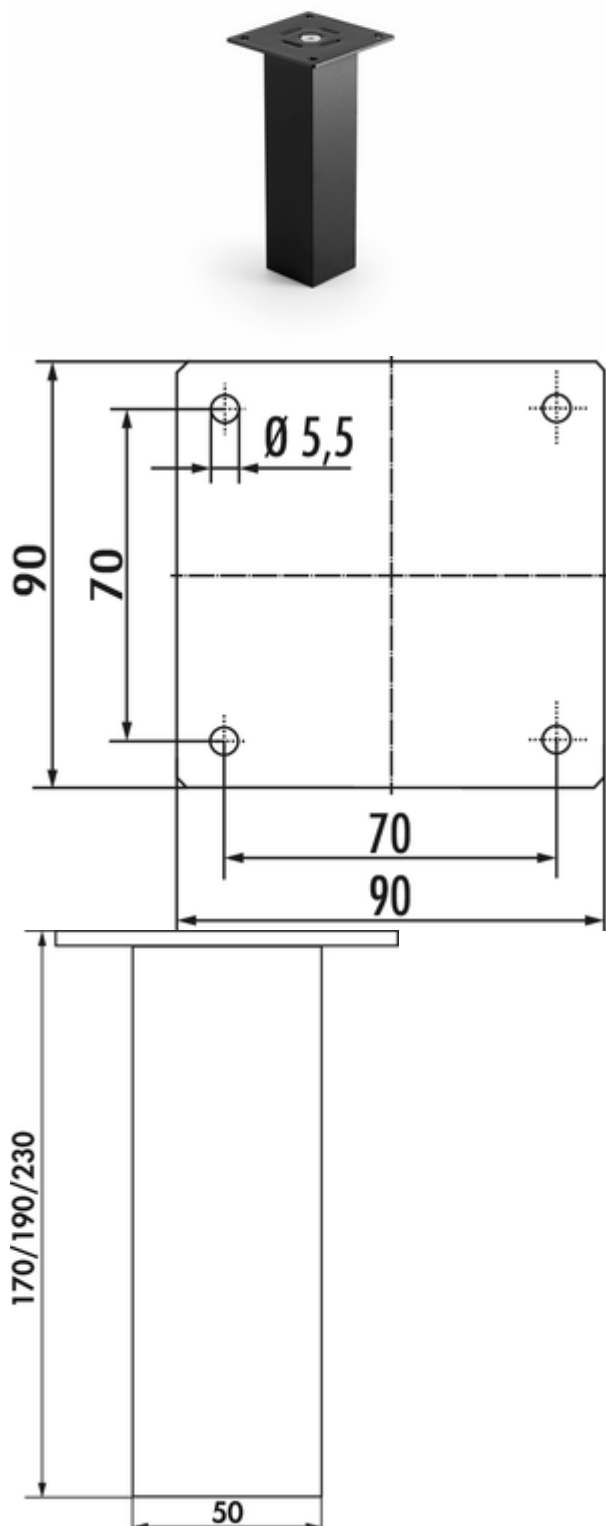

✓ Console

✓ Material: aluminium

✓ angular

Console. Aluminium profile 50 x 50 mm.

— straight

— max. load per pair approx. 60 kg given even distribution, max. spacing of the consoles of 900 mm and max. projection of the plates of 250 mm

[more infos...](#)

Technical data

Article type	Console	Carrying capacity	max. load per pair approx. 60 kg given even distribution, max. spacing of the consoles of 900 mm and max. projection of the plates of 250 mm
Height	190 mm	Inclination angle	0°
Width	50 mm	Support element version	straight
Material	aluminium	Dimensions support surface	90 x 90 mm
Shape	angular	Material profile	aluminium
Dimensions profile	50 x 50 mm		

Dimensional sketch (PDF)

