

Model 41

Product number: 3021066

Configuration: stainless steel, H 230 mm, tube Ø 50 mm

Configuration options

3021063 | stainless steel, H 190 mm, tube Ø 50 mm

3021066 | stainless steel, H 230 mm, tube Ø 50 mm

- ✓ Console
- ✓ Material: stainless steel
- ✓ round

Console. With bolted connection.

— max. load per pair approx. 60 kg given even distribution, max. spacing of the consoles of 900 mm and max. projection of the plates of 250 mm

When using the glass adapter disk (3021056) bonding should be performed by a glazier.

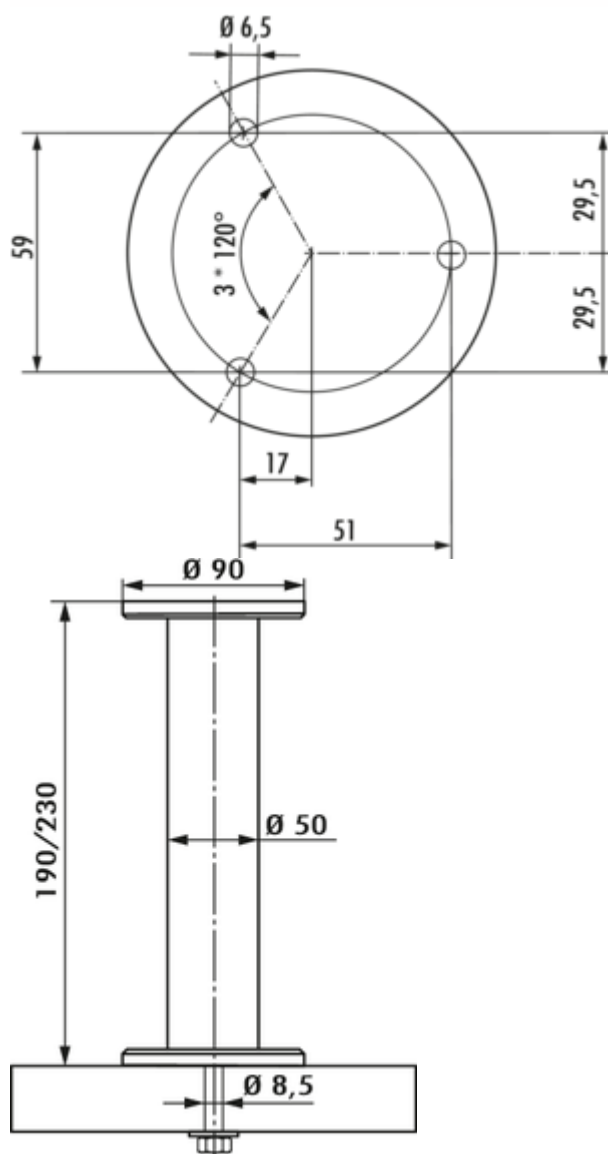

[more infos...](#)

Technical data

Article type	Console	Shape	round
Height	230 mm	Carrying capacity	max. load per pair approx. 60 kg given even distribution, max. spacing of the consoles of 900 mm and max. projection of the plates of 250 mm
Width	90 mm	Outer diameter	90 mm
Material	stainless steel	Tube dimension	Ø 50 mm
Mounting/Fixing	Screw fastening	Diameter bearing surface	90 mm
Note	When using the glass adapter disk (3021056) bonding should be performed by a glazier.	Support element version	straight

Dimensional sketch (PDF)

